

Table of Contents

Introduction	19
SwitcherCAD III Overview	19
Hardware Requirements.....	20
Software Installation	20
License Agreement/Disclaimer.....	21
Modes of Operation	23
Overview.....	23
Synthesized Circuits	24
Application Note Circuits	25
Example Circuits.....	26
General Purpose Schematic Driven SPICE	27
Externally Generated Netlists	28
Efficiency Report	29
Schematic Capture	31
Basic Schematic Editing	31
Label a node name	35
Schematic Colors	36
Placing New Components	37
Programming Keyboard Shortcuts	37
PCB Netlist Extraction	38
Editing Components	38
Editing Components.....	38
Edit a visible attribute.....	39
Specialized Component Editors.....	40
General Attribute Editor	41
Creating New Symbols.....	43
Symbol Editing Overview	43
Drawing the body	43
Adding the Pins	44
Adding Attributes.....	45
Attribute Visibility.....	47
Hierarchy	48
Hierarchy Overview.....	48
Rules of Hierarchy.....	49
Navigating the Hierarchy.....	50
Waveform Viewer	52
Overview.....	52
Trace Selection.....	52
Zooming.....	56
Waveform Arithmetic	56
User-Defined Functions.....	61
Axis Control	62
Plot Panes	62
Color Control.....	63
Attached Cursors.....	64
Save Plot Configurations	67

LTspice 68

Introduction.....	69
Circuit Description.....	69
General Structure and Conventions.....	69
Circuit Element Quick Reference.....	72
Dot Commands.....	73
C. Simulator directives -- dot commands.....	73
.AC -- Perform an small signal AC analysis.....	74
.BACKANNO -- Annotate the subcircuit pin names to the port currents.....	74
.DC -- Perform a DC source sweep analysis.....	75
.END -- End of netlist.....	75
.ENDS -- End of Netlist.....	76
.FOUR -- Compute a Fourier component after a transient analysis.....	76
.FUNC - User defined functions.....	76
.GLOBAL -- Declare global nodes.....	77
.IC -- Set initial conditions.....	78
.INCLUDE -- Include another file.....	78
.LIB -- Include a library.....	79
.MODEL -- Define a SPICE model.....	79
.NODESET -- Supply hints for initial DC solution.....	80
.NOISE -- Perform a noise analysis.....	81
.OP -- Find the DC operating point.....	81
.OPTIONS -- Set simulator options.....	82
.PARAM -- User-defined parameters.....	84
.SAVE -- Limit the amount of saved data.....	86
.STEP -- Parameter sweeps.....	86
.SUBCKT -- Define a subcircuit.....	87
.TEMP -- Temperature sweeps.....	88
.TF -- Find the DC small-signal transfer function.....	89
.TRAN -- Perform a nonlinear transient analysis.....	89
.WAVE -- Write selected nodes to a .wav file.....	90
Transient Analysis Options.....	91
.TRAN Modifiers.....	91
UIC.....	91
startup.....	92
steady.....	92
nodiscard.....	92
step.....	92
Circuit Elements.....	93
A. Special functions.....	93
B. Arbitrary behavioral voltage or current sources.....	96
C. Capacitor.....	99
D. Diode.....	102
E. Voltage Dependent Voltage Source.....	104
F. Current Dependent Current Source.....	106
G. Voltage Dependent Current Source.....	106
H. Current Dependent Voltage Source.....	108
I. Current Source.....	108
J. JFET transistor.....	113
K. Mutual Inductance.....	114
L. Inductor.....	115
M. MOSFET.....	117
O. Lossy Transmission Line.....	126
Q. Bipolar transistor.....	127
R. Resistor.....	131

S. Voltage Controlled Switch	131
T. Lossless Transmission Line.....	132
U. Uniform RC-line	133
V. Voltage Source	134
W. Current Controlled Switch.....	138
X. Subcircuit	139
Z. MESFET transistor.....	140
Control Panel	141
Accessing the Control Panel	141
Compression.....	142
Operation	143
Save Defaults	145
SPICE	146
Netlist Options	148
Hacks.....	148
Drafting Options.....	149
Internet Option	151
FAQs	152
Program Updates	153
Transformer Models	154
Third-party Models.....	154
Inductor Models	156
MOSFET Models	157
License and Distribution	157
Circuit Efficiency Calculation	158
Custom Symbol	159
Memory Problems	160
Model Compatibility	161
SPICE Netlist.....	162
Exporting/Merging Waveform Data	162
Runing under Linux	163
Appendixes	164
Symbols	164
Symbol Overview	164
Power Products.....	164
Overview.....	164
LT1308A.....	165
LTC1435A	167
LTC1735.....	167
LTC1628.....	167
LTC1624.....	168
LTC1622.....	168
LT1026.....	168
LT1054.....	168
LT1054L.....	168
LT1070.....	168
LT1070HV	169
LT1071.....	169
LT1071HV	169
LT1072.....	169
LT1072HV	169
LT1073.....	169
LT1073-5	169

LT1073-12	169
LT1074.....	169
LT1074HV	169
LT1076.....	169
LT1082.....	170
LT1084.....	170
LT1085.....	170
LT1103.....	170
LT1105.....	170
LT1106.....	170
LT1107.....	170
LT1107-5	170
LT1107-12	170
LT1108.....	170
LT1108-12	170
LT1109.....	170
LT1109-12	171
LT1109-5	171
LT1110-5	171
LT1110-12	171
LT1111.....	171
LT1111-5	171
LT1170.....	171
LT1170HV	171
LT1171.....	171
LT1171HV	171
LT1172.....	172
LT1172HV	172
LT1173.....	172
LT1173-5	172
LT1173-12	172
LT1176.....	172
LT1176-5	172
LT1182.....	172
LT1183.....	172
LT1184.....	172
LT1184F	173
LT1186F	173
LT1242.....	173
LT1243.....	173
LT1245.....	173
LT1246.....	173
LT1247.....	173
LT1248.....	173
LT1249.....	173
LT1269.....	173
LT1268.....	174
LT1268B	174
LT1270.....	174
LT1270A	174
LT1271.....	174
LT1300.....	174
LT1301.....	174
LT1302.....	174
LT1302-5	174
LT1303.....	175

LT1303-5	175
LT1304.....	175
LT1304-3.3	175
LT1304-5	175
LT1305.....	175
LT1306.....	176
LT1307.....	176
LT1307B	176
LT1309.....	176
LT1316.....	176
LT1317.....	176
LT1317B	176
LT1336.....	176
LT1370.....	177
LT1371.....	177
LT1371HV	177
LT1372.....	177
LT1372HV	177
LT1373.....	177
LT1373HV	177
LT1374.....	177
LT1374-5	177
LT1375.....	178
LT1375HV	178
LT1375-5	178
LT1376.....	178
LT1376HV	178
LT1376-5	178
LT1377.....	178
LT1339.....	179
LT1424-5	179
LT1424-9	179
LT1425.....	179
LT1432.....	179
LT1432-3.3	179
LT1500.....	179
LT1501.....	179
LT1501-3.3	179
LT1501-5	179
LT1505.....	179
LT1505-1	180
LT1506.....	180
LT1506-3.3	180
LT1500-3	180
LT1507.....	180
LT1507-3.3	180
LT1508.....	180
LT1509.....	180
LT1510-5	180
LT1510.....	181
LT1512.....	181
LT1529.....	181
LT1533.....	181
LT1534.....	181
LT1572.....	181
LT1576.....	181

LT1578.....	181
LT1576-5	181
LT1612.....	181
LT1613.....	182
LT1614.....	182
LT1615.....	182
LT1617.....	182
LT1618.....	182
LT1610.....	182
LT1611.....	182
LT1615-1	182
LT1616.....	182
LT1617.....	182
LT1617-1	183
LT1619.....	183
LT1620.....	183
LT1620S8	183
LT1621.....	183
LT1676.....	183
LT1680.....	183
LT1725.....	183
LT1735.....	183
LT1737.....	183
LT1761-1.8	183
LT1761-2.5	184
LT1761-3	184
LT1761-5	184
LT1761-BYP	184
LT1761-SD	184
LT1761-3.3	184
LT1762.....	184
LT1762-1.5	184
LT1762-1.8	184
LT1762-2.5	184
LT1762-3.3	185
LT1762-3	185
LT1762-5	185
LT1763.....	185
LT1763-1.5	185
LT1763-1.8	185
LT1763-2.5	185
LT1763-3.3	185
LT1763-3	185
LT1763-5	185
LT1764.....	186
LT1764-1.5	186
LT1764-1.8	186
LT1764-2.5	186
LT1764-3.3	186
LT1767.....	186
LT1776.....	186
LT1777.....	186
LT1786F	186
LT1930.....	186
LT1930A.....	187
LT1931.....	187

LT1931A.....	187
LT1949.....	187
LT1956.....	187
LT1959.....	187
LT1962.....	187
LT1962-1.5.....	187
LT1962-1.8.....	187
LT1962-2.5.....	187
LT1962-3.....	187
LT1962-5.....	188
LT1963.....	188
LT1963-1.5.....	188
LT1963-1.8.....	188
LT1963-2.5.....	188
LT1963-3.3.....	188
LT1956-5.....	188
LTC660.....	188
LTC1044.....	188
LTC1044A.....	188
LTC1046.....	189
LTC1142.....	189
LTC1142HV.....	189
LTC1142HV-ADJ.....	189
LTC1142L-ADJ.....	189
LTC1143.....	189
LTC1143L.....	189
LTC1143L-ADJ.....	189
LTC1144.....	189
LTC1147-3.3.....	189
LTC1148L.....	190
LTC1148L-3.3.....	190
LTC1149.....	190
LTC1149-3.3.....	190
LTC1149-5.....	190
LTC1159.....	190
LTC1159-3.3.....	190
LTC1626.....	190
LTC1159-5.....	190
LTC1174.....	190
LTC1174-3.3.....	191
LTC1174-5.....	191
LTC1174HV.....	191
LTC1174HV-3.3.....	191
LTC1174HV-5.....	191
LTC1261.....	191
LTC1261CS8.....	191
LTC1261LCS8.....	191
LTC1261LCS8-4.....	191
LTC1261LCS8-4.5.....	191
LTC1262.....	192
LTC1263.....	192
LTC1265.....	192
LTC1265-3.3.....	192
LTC1265-5.....	192
LTC1266.....	192
LTC1266-3.3.....	192

LTC1266-5.....	192
LTC1267.....	192
LTC1267-ADJ.....	192
LTC1267-ADJ5.....	192
LTC1430.....	193
LTC1430A.....	193
LTC1433.....	193
LTC1434.....	193
LTC1436A.....	193
LTC1436A-PLL.....	193
LTC1437A.....	193
LTC1438-ADJ.....	193
LTC1438.....	193
LTC1439.....	194
LTC1474.....	194
LTC1475.....	194
LTC1475-5.....	194
LTC1502-3.3.....	194
LTC1503-1.8.....	194
LTC1503-2.....	194
LTC1504.....	194
LTC1504-3.3A.....	194
LTC1504A.....	194
LTC1504-3.3.....	195
LTC1514-3.3.....	195
LTC1514-5.....	195
LTC1515.....	195
LTC1515-3.3/5.....	195
LTC1515-3/5.....	195
LTC1516.....	195
LTC1517-3.3.....	195
LTC1517-5.....	195
LTC1522.....	195
LTC1530.....	195
LTC1530-1.9.....	196
LTC1530-2.5.....	196
LTC1530-3.3.....	196
LTC1530-2.8.....	196
LTC1538-AUX.....	196
LTC1539.....	196
LTC1550.....	196
LTC1550L.....	196
LTC1550LCS8.....	196
LTC1550LCS8-2.....	196
LTC1550LCS8-2.5.....	197
LTC1550LCS8-4.1.....	197
LTC1550CS8-4.1.....	197
LTC1553.....	197
LTC1553L.....	197
LTC1574.....	197
LTC1574-3.3.....	197
LTC1574-5.....	197
LTC1625.....	197
LTC1625-5.....	198
LTC1626-3.3.....	198
LTC1627.....	198

LTC1628-PG	198
LTC1629	198
LTC1629-PG	198
LTC1649	198
LTC1682	198
LTC1682-3.3	198
LTC1682-5	198
LTC1693-1	199
LTC1693-2	199
LTC1693-3	199
LTC1701	199
LTC1701B	199
LTC1702	199
LTC1703	199
LTC1706-19	199
LTC1707	199
LTC1709	199
LTC1735-1	199
LTC1736	200
LTC1753	200
LTC1754-5	200
LTC1771	200
LTC1772B	200
LTC1772	200
LTC1773	200
LTC1775	200
LTC1778	200
LTC1779	200
LTC1871	201
LTC1872	201
LTC1872B	201
LTC1874	201
LTC1873	201
LTC1877	201
LTC1878	201
LTC1922-1	201
LTC1929	201
LTC1929-PG	201
LTC1986	202
LTC3200	202
LTC3200-5	202
LTC3401	202
LTC3402	202
LTC3404	202
LTC3405	202
LTC3716	202
LTC3711	202
LTC3713	202
LTC3714	203
LTC3728	203
LTC3729	203
Operational Amplifiers	203
LT1001	203
LT1001A	203
LT1001S8	203
LT1002	203

LT1002A.....	203
LT1006.....	203
LT1006A.....	203
LT1006S8.....	203
LT1007.....	204
LT1007A.....	204
LT1007CS.....	204
LT1008.....	204
LT1010.....	204
LT1012.....	204
LT1012A.....	204
LT1012D.....	204
LT1012S8.....	204
LT1013.....	204
LT1013A.....	204
LT1013D.....	205
LT1014.....	205
LT1014A.....	205
LT1014D.....	205
LT1022.....	205
LT1022A.....	205
LT1024.....	205
LT1024A.....	205
LT1028.....	205
LT1028A.....	205
LT1028CS.....	205
LT1028N.....	206
LT1037.....	206
LT1037A.....	206
LT1037CS.....	206
LT1055.....	206
LT1055A.....	206
LT1055S8.....	206
LT1056.....	206
LT1056A.....	206
LT1056S8.....	206
LT1057.....	206
LT1057A.....	207
LT1057S.....	207
LT1058.....	207
LT1058A.....	207
LT1077.....	207
LT1077A.....	207
LT1078.....	207
LT1078A.....	207
LT1079.....	207
LT1079A.....	207
LT1097.....	208
LT1101.....	208
LT1101A.....	208
LT1102.....	208
LT1102A.....	208
LT1112.....	208
LT1113.....	208
LT1114.....	208
LT1115.....	208

LT1122.....	208
LT1124.....	209
LT1125.....	209
LT1126.....	209
LT1127.....	209
LT1128.....	209
LT1167.....	209
LT1168.....	209
LT1169.....	209
LT1178.....	209
LT1178A.....	209
LT1179.....	210
LT1179A.....	210
LT1187.....	210
LT1189.....	210
LT1190.....	210
LT1191.....	210
LT1193.....	210
LT1194.....	210
LT1195.....	210
LT1206.....	210
LT1207.....	210
LT1208.....	210
LT1209.....	211
LT1210.....	211
LT1211.....	211
LT1212.....	211
LT1213.....	211
LT1214.....	211
LT1215.....	211
LT1216.....	211
LT1217.....	211
LT1218.....	211
LT1219.....	211
LT1220.....	212
LT1221.....	212
LT1222.....	212
LT1223.....	212
LT1224.....	212
LT1225.....	212
LT1226.....	212
LT1227.....	212
LT1228.....	212
LT1229.....	212
LT1230.....	212
LT1251.....	212
LT1252.....	213
LT1253.....	213
LT1254.....	213
LT1256.....	213
LT1259.....	213
LT1260.....	213
LT1328.....	213
LT1328PD.....	213
LT1351.....	213
LT1352.....	213

LT1353.....	213
LT1354.....	214
LT1355.....	214
LT1356.....	214
LT1357.....	214
LT1358.....	214
LT1359.....	214
LT1360.....	214
LT1361.....	214
LT1362.....	214
LT1363.....	214
LT1364.....	214
LT1365.....	214
LT1366.....	214
LT1367.....	215
LT1368.....	215
LT1369.....	215
LT1395.....	215
LT1396.....	215
LT1397.....	215
LT1398.....	215
LT1399.....	215
LT1413.....	215
LT1413A.....	215
LT1431.....	215
LT1462.....	216
LT1463.....	216
LT1464.....	216
LT1465.....	216
LT1466.....	216
LT1466L.....	216
LT1467.....	216
LT1467L.....	216
LT1468.....	216
LT1468N.....	216
LT1469.....	217
LT1490.....	217
LT1491.....	217
LT1492.....	217
LT1493.....	217
LT1495.....	217
LT1496.....	217
LT1497.....	217
LT1498.....	217
LT1499.....	217
LT1630.....	218
LT1631.....	218
LT1632.....	218
LT1633.....	218
LT1635.....	218
LT1636.....	218
LT1637.....	218
LT1638.....	218
LT1639.....	218
LT1677.....	218
LT1782.....	218

LT1783.....	219
LT1787.....	219
LT1793.....	219
LT1795.....	219
LT1806.....	219
LT1807.....	219
LT1809.....	219
LT1792.....	219
LT1810.....	219
LT1812.....	220
LT1881.....	220
LT1884.....	220
LT1886.....	220
LT1920.....	220
LT2078.....	220
LT2078A.....	220
LT2079.....	220
LT2079A.....	220
LT2178.....	220
LT2178A.....	221
LT2179.....	221
LT2179A.....	221
LTC1043.....	221
LTC1047.....	221
LTC1049.....	221
LTC1050.....	221
LTC1050A.....	221
LTC1051.....	221
LTC1051A.....	221
LTC1052.....	222
LTC1052CS.....	222
LTC1053.....	222
LTC1100.....	222
LTC1100A.....	222
LTC1150.....	222
LTC1151.....	222
LTC1152.....	222
LTC1250.....	222
LTC1541.....	222
LTC1542.....	222
LTC2050.....	223
LTC7652.....	223
OPAMP.....	223
Miscellaneous.....	223
Voltage.....	223
OR.....	223
SCHMITT.....	224
SCHMTINV.....	224
XOR.....	224
SCHMTBUF.....	225
AND.....	225
BI.....	226
BI2.....	226
BV.....	226
BUF.....	226
BUF1.....	226

INV.....	227
CAP.....	227
POLCAP.....	227
CAPMETER.....	227
SCHOTTKY.....	227
ZENER.....	227
DIODE.....	228
DFLOP.....	228
E2.....	228
G2.....	228
CURRENT.....	228
LOAD.....	229
LOAD2.....	229
NJF.....	229
PJF.....	229
IND.....	229
IND2.....	229
NMOS.....	229
NMOS4.....	229
PMOS.....	230
PMOS4.....	230
LTLINE.....	230
NPN.....	230
NPN2.....	230
PNP.....	230
PNP2.....	231
RES.....	231
RES2.....	231
SW.....	231
TLINE.....	231
SIGNAL.....	231
CSW.....	231
OPAMP.....	231
OPAMP2.....	232
MESFET.....	232
XTAL.....	232
CELL.....	232
DIP10.....	232
DIP14.....	232
DIP16.....	233
DIP20.....	233
DIP8.....	233
JUMPER.....	233
SIGNAL.....	233
URC.....	234
URC2.....	234
BATTERY.....	234
Opto Isolators.....	234
4N25.....	234
4N25A.....	234
4N26.....	234
4N27.....	235
4N28.....	235
CNY17-1.....	235
CNY17-2.....	235
CNY17-3.....	235

MOC205	235
MOC206	235
MOC207	235
PC817A	235
PC817B	235
PC817C	235
PC817D	235
Special Functions	236
MODULATE	236
CAPMETER	236
VARISTOR	236
Filter Products	236
LTC1562-2	236
LTC1562	236
LTC1562A	236
Digital	237
AND	237
BUF	237
BUF1	237
DFLOP	238
INV	238
OR	238
SCHMITT	239
SCHMTBUF	239
SCHMTINV	240
SRFLOP	240
XOR	240
Diffschmtinv	240
Diffschmtbuf	241
Diffschmitt	241
PHIDET	242
Comparators	242
LT1016	242
LT1116	242
LT1394	242
LT1671	242
LT1720	242
LT1721	242
LTC1041	242
LTC1042	243
LTC1440	243
LTC1441	243
LTC1442	243
LTC1443	243
LTC1444	243
LTC1445	243
LTC1540	243
Preface	244

SPICE Error Log Command	246
Web Update	247
1107	247
1173	247
E	247
F	247
G	247
H	248
LT1071	248
LT1072	248
LT1074	248
LT1083	248
LT1109	248
LT1109-12	248
LT1109-5	248
LT1109A	248
LT1109A-12	248
LT1109A-5	248
LT1170	249
LT1170HV	249
LT1171	249
LT1171HV	249
LT1172	249
LT1172HV	249
LT1241	249
LT1300	249
LT1301	249

LT1302	249	
LT1303	249	
LT1303-5	249	
LT1304	250	
LT1304-3.3	250	
LT1304-5	250	
LT1305	250	
LT1307	250	
LT1307B	250	
LT1308A	250	
LT1308B	250	
LT1309	250	
LT1316	250	
LT1375	250	
LT1375-5	251	
LT1108	251	
LT1111-12	251	
LT1110	251	
LTC1261CS8-4		251
LTC1551CS8-4.1		251
LTC1551LCS8		251
LTC1551LCS8-4.1		251
LT1962-3.3	251	
LT1761-2	251	
LTC1475-3.3		251
LT1615	252	
LTC1147-5	252	

LTC1147L	252	
LTC1147L-3.3		252
LTC1148	252	
LTC1148-3.3		252
LTC1148-5	252	
LTC1148HV	252	
LTC1148HV-3.3		252
LTC1148HV-5		252
LT1244	253	
LT1813	253	
opto isolator section		253
special function blocks		253
Filterproducts		253
misc symbols		253

Introduction

SwitcherCAD III Overview

SwitcherCAD III is the third generation switching regulator design program by Linear Technology. The program consists of a high performance SPICE simulator extended with a mixed mode simulation capability that includes new intrinsic SPICE devices for macromodelling Switch Mode Power Supply (SMPS) controllers and regulators. The program includes an integrated hierarchical schematic capture program that allows users to edit example SMPS circuits or design new circuits. An integrated waveform viewer displays the simulated waveforms and allows further analysis of the simulation data. There is a built-in database for most of Linear Technology's power ICs and many passive components. The device database, schematic editing, simulation control and waveform analysis are integrated into one program.

Due to the mixed mode simulation capability and many other enhancements over previous SPICE programs, the simulation speed is greatly improved while simulation accuracy is retained. Detailed cycle-by-cycle SMPS simulations can be performed and analyzed in minutes. A user can get a detailed analysis of power systems with a few mouse clicks without knowing anything about the device, SPICE or the schematic capture program. Synthesized or pre-drafted demo circuits can be used as a starting point to build the custom circuit to fit different power supply requirements. After the new schematic is created, the system can be simulated and a report generated.

The program's integrated hierarchical schematic capture and SPICE simulator is completely available for general use. The improved performance of the SPICE simulation engine is a benefit for simulating general analog circuits and should be of interest to all electronic engineers. With over 100,000 copies distributed so far, many users have reported that LTspice/SwitcherCAD III is their main simulation/schematic capture tool. We hope you enjoy the program and find it useful.

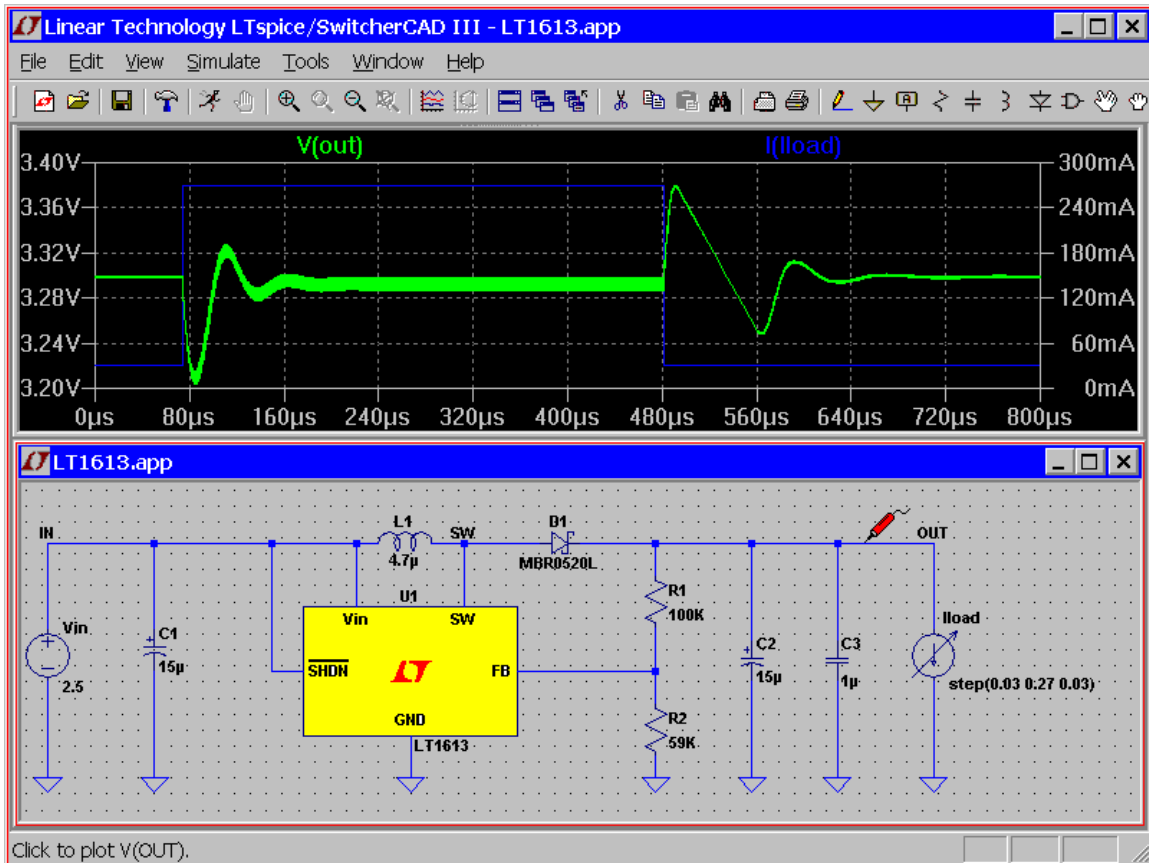

Hardware Requirements

LTspice/SwitcherCAD III runs on PC's running Windows 95, 98, 2000, NT4.0, Me, or XP. It doesn't work under Windows 3.1 or DOS. Since a simulation can generate many megabytes of data in a few minutes, free hard disk space (>200MB) and large amount of RAM (>128MB) are highly recommended. Basically, the program can run on any PC with Windows 95 or above, but the simulation may not finish if there is not enough hard disk space.

LTspice/SwitcherCAD III will also run on Linux. The program has been tested on Linux RedHat 8.0 with WINE verion 20030219.

Software Installation

SwitcherCAD III can be downloaded from the LTC website, <http://www.linear.com/software>. A direct link to the distributed file is <http://ltspice.linear.com/software/swcadiii.exe>. The file swcadiii.exe is a self-extracting gzipped file that installs SwitcherCAD III as it extracts.

SwitcherCAD III is updated often. After SwitcherCAD III is initially installed, you can use a built-in `update` menu command that will bring your installation to the current revision level if you have access to the web. The update process will first download a master index file from Linear's website that has the size and checksum of each file in the distribution. If there is a file missing, of a different size, or a difference between the local checksum and the one from the index file, then that file will be updated automatically. Component databases are merged in the update process so if you've added devices to your installation, those additions won't be lost when you run the automatic update utility.

License Agreement/Disclaimer

SwitcherCAD III -- License Agreement/Disclaimer

Copyright © 2001, Linear Technology Corporation

All rights reserved.

SwitcherCAD III is Linear Technology Corporation's switch mode power supply synthesis and analog circuit simulation software.

This software is copyrighted. You are granted a non-exclusive, non-transferable, non-sublicenseable, royalty-free right solely to evaluate LTC products and also to perform general circuit simulation. Linear Technology Corporation owns the software. You may not modify, adapt, translate, reverse engineer, decompile, or disassemble the software executable(s) or models of LTC products provided. We take no responsibility for the accuracy of third party

models used in the simulator whether provided by LTC or the user.

While we have made every effort to ensure that SwitcherCAD III operates in the manner described, we do not guarantee operation to be error free. Upgrades, modifications, or repairs to this program will be strictly at the discretion of LTC. If you encounter problems installing or operating SwitcherCAD III for the purpose of selecting and evaluating LTC products, you may obtain technical assistance by calling our Applications Department at (408) 432-1900, between 8:00 am and 5:00 pm Pacific time, Monday through Friday. We do not provide such technical support for general circuit simulations that are not for the evaluation of LTC products. Because of the great variety of PC-compatible computer systems, operating system versions, and peripherals currently in use, we do not guarantee that you will be able to use SwitcherCAD III successfully on all such systems. If you are unable to use SwitcherCAD III, LTC does provide design support for LTC switching regulator ICs by whatever means necessary.

The software and related documentation are provided "AS IS" and without warranty of any kind and Linear Technology Corporation expressly disclaims all other warranties, express or implied, including, but not limited to, the implied warranties of merchantability and fitness for a particular purpose. Under no circumstances will LTC be liable for damages, either direct or consequential, arising from the use of this product or from the inability to use this product, even if we have been informed in advance of the possibility of such damages.

Redistribution of this software is permitted as long as it is distributed in its entirety, with all documentation, example files, symbols, and models without modification or additions.

This program is specifically not licensed for use by semiconductor manufacturers in the promotion, demonstration or sale of their products. Specific permission must be obtained from Linear Technology for the use of SwitcherCAD III for these applications.

Modes of Operation

Overview

SwitcherCAD III has five basic modes of driving the simulator:

1. Run a circuit synthesized by SwitcherCAD III from your power supply specification. Menu command File=>Switch Selector Guild.
2. Run an application note circuit. Menu command File=>Demo SMPS Circuits.
3. Run an example circuit distributed with the program. Menu command File=>Open, and then open one of the examples directory examples\SMPS*
4. Use the program as a general-purpose schematic capture program with an integrated simulator. Menu commands File=>New, and File=>Open(file type .asc)
5. Feed the simulator with a handcrafted netlist or a foreign netlist generated with a different schematic capture tool. Menu command File=>Open(file type .cir)

The first two modes, application note circuits and sample circuits, require no knowledge of SPICE syntax to run. One simply selects one of three types of simulations; steady state, start-up transient, and step load response. The circuits contain hidden information about appropriate initial conditions for each simulation type. The circuits can be edited by the user and re-simulated, but extensive edits may impair the success of the simulation. These simulations each require automatic detection of the switchmode power supply's steady state. This is written into the models and is usually detected by noting when the error amp current drops to near zero and stays there. Schematic files meant to run in this mode have a file extension of ".app".

In the next two modes, all the SPICE commands are visible by the user. There is a menu item, Edit simulation command, which helps you write the SPICE directive to run a

simulation. Schematic files meant to run in this mode have a file extension of ".asc".

All four modes ultimately convert the circuit file to a textual SPICE netlist. The netlist is usually extracted from a graphical schematic. Alternately, an imported netlist can be run directly without having a schematic. This has several uses: (i) Linear Technology's filter synthesis program, FilterCAD, can synthesize a netlist for LTspice to simulate the time domain or frequency response of a filter. (ii) it simplifies benchmarking LTspice against other SPICE programs (iii) professionals historically experienced with SPICE circuit simulators are familiar with working directly with the textual netlists because schematic capture was not integrated with SPICE simulators in older systems.

Synthesized Circuits

SwitcherCAD III can automatically design a SMPS from your specification. Use the menu command File=>Switch Selector Guild.

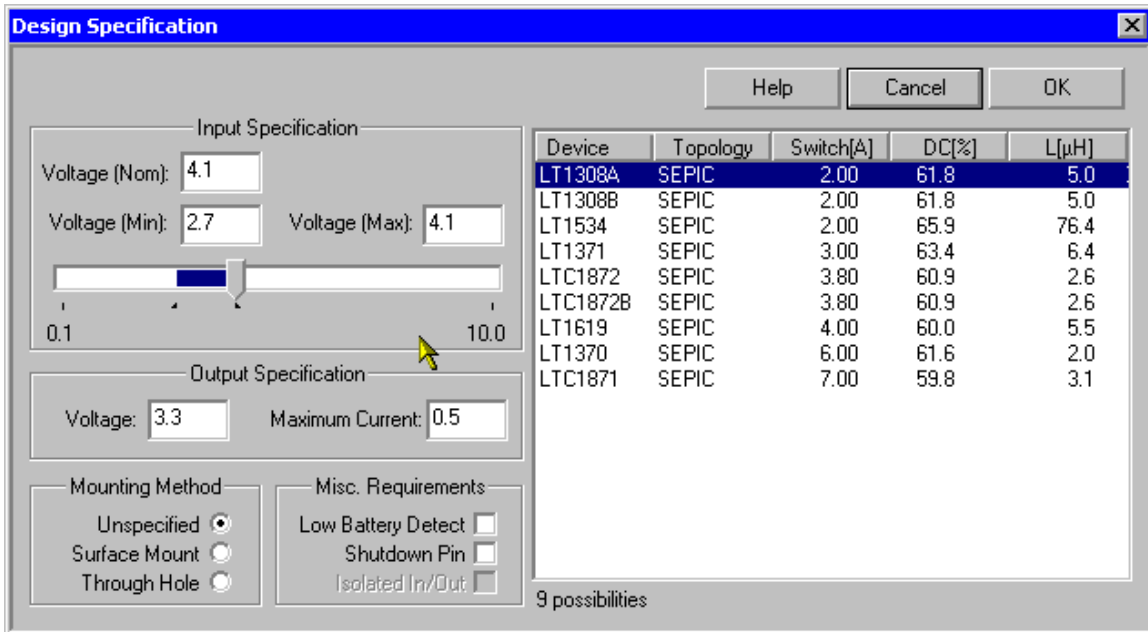

If a design can be found for your specification, it should work for the worst case part. Note that the macromodels are based on typical performance. That means that if the synthesizer finds a solution and you then increase the output power, the design may not work at that load over the product distribution. Also, no temperature considerations are made. All circuits designed by the synthesizer will keep the output voltage in regulation even down to zero output current. Hence only a maximum output current is required in the specification.

The design that comes out of the synthesizer is not optimized. It just tries to find a solution with the lowest possible current rating switch.

Three types of analyses appear under the simulate menu command for circuits out of the synthesizer: steady-state, start-up transient, and step-load response. No knowledge of SPICE syntax is required to perform these analyses.

It is possible to edit the circuits, however, if extensive edits are performed the circuit may no longer function.

Circuits designed by the synthesizer can be saved. By default, they will be saved with a file extension of ".app" but can also be saved with a file extension of ".asc"

Application Note Circuits

There is a library of demo SMPS Circuits that you can run with the menu command File=>Demo SMPS Circuits.

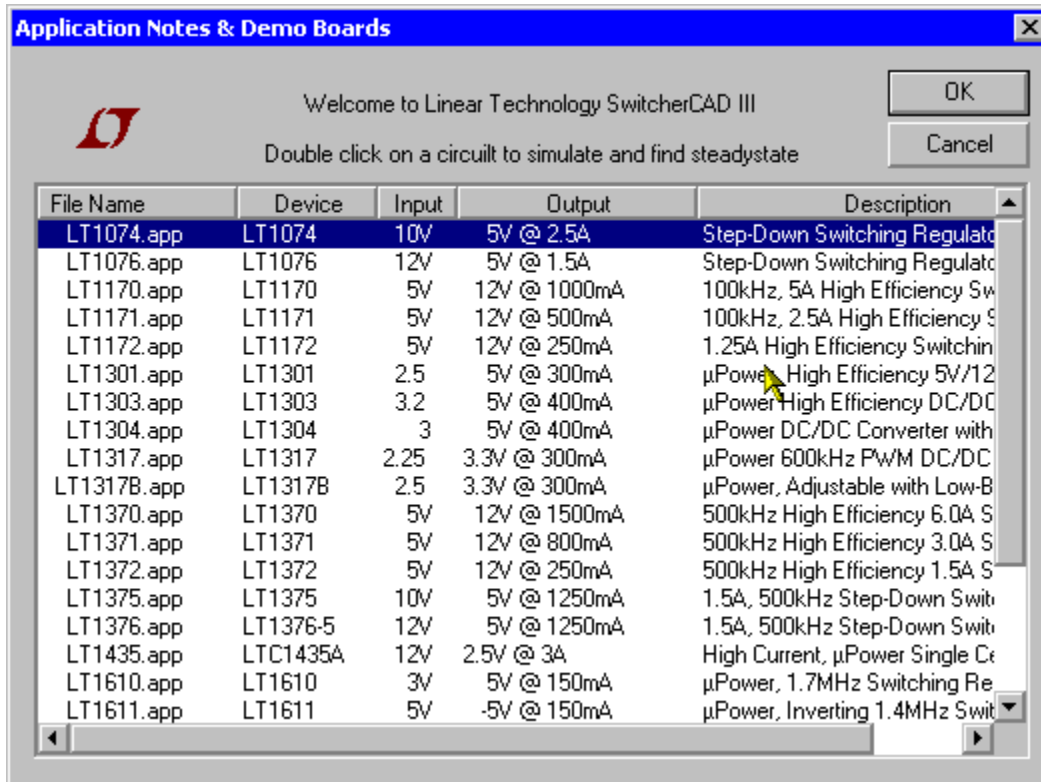

Analysis of these circuits is the same as for the synthesized circuits. This mode of operation is basically obsolete and has been replaced by the synthesized circuit mode. These circuits can be edited and modified. By default, they will be saved with a file extension of ".app" but can also be saved with a file extension of ".asc"

Example Circuits

Ltspice/SwitcherCAD III ships with many example SMPS circuits. These are typically installed in the directory C:\Program Files\LTC\SwCADIII\examples\SMPS\{buck,boost, etc.} and have a file extension of ".asc". The SPICE commands are clearly visible on the schematic.

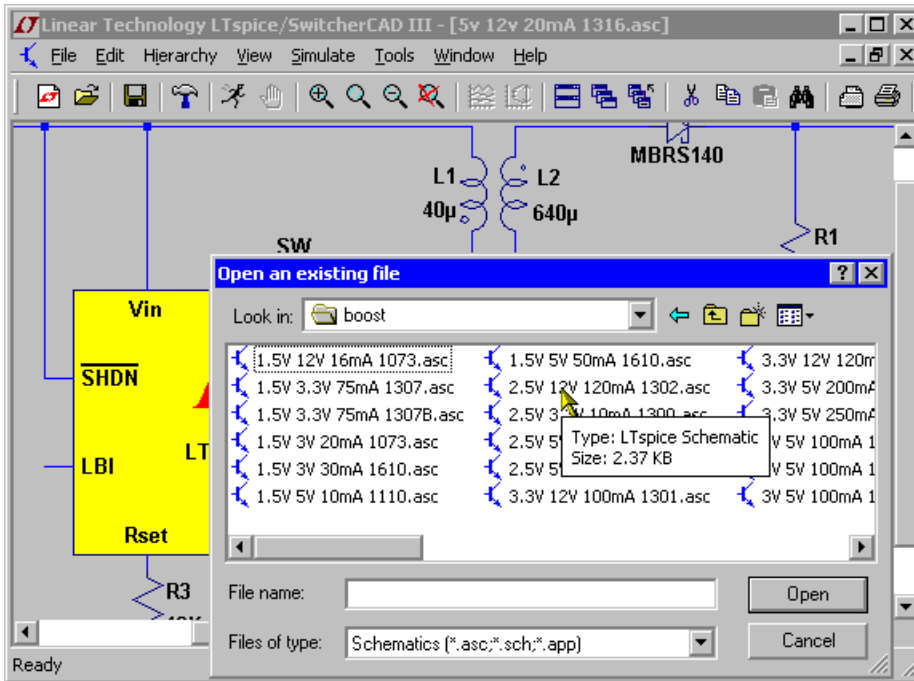

General Purpose Schematic Driven SPICE

You are free to use LTspice/SwitcherCAD III as a general-purpose schematic capture/SPICE program. This is useful not only for SMPS design, but many aspects of analog engineering. The example circuits typically installed in the directory C:\Program Files\LTC\SwCADIII\examples\Educational\ illustrate various LTspice capabilities.

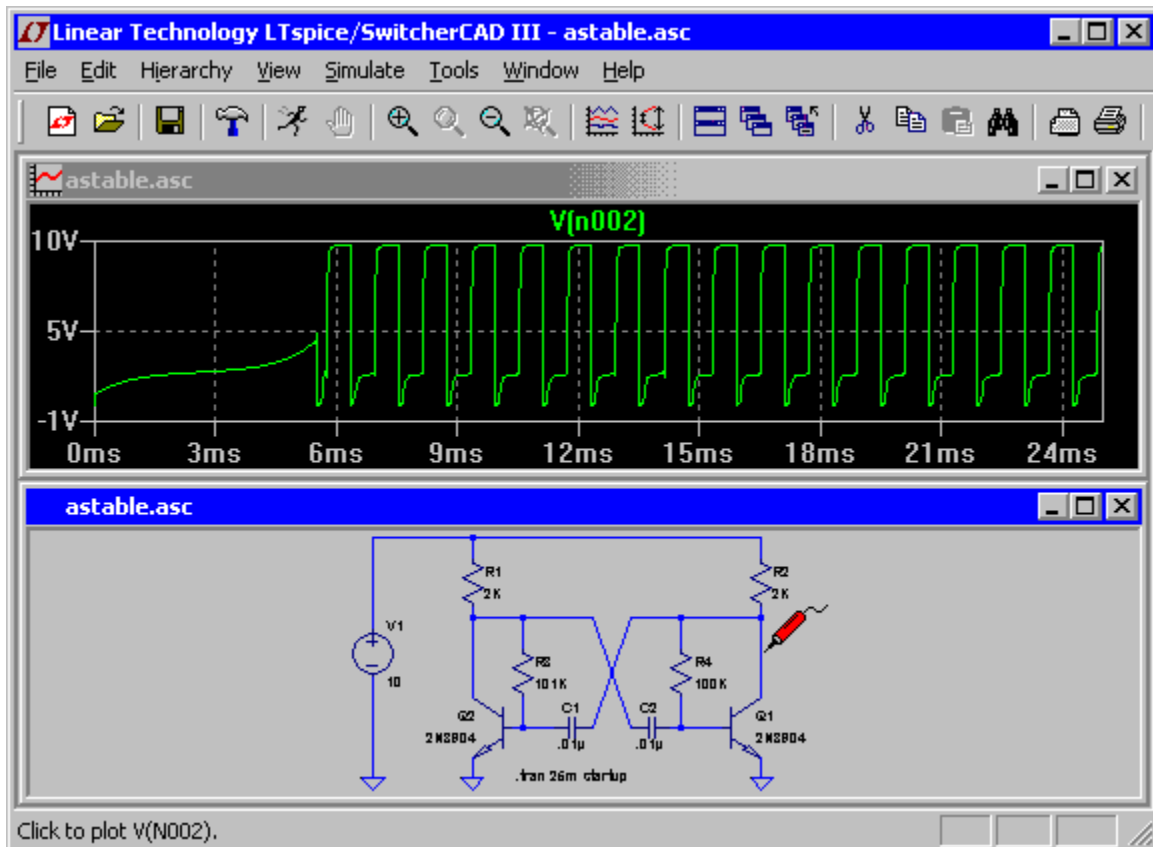

Externally Generated Netlists

You can open netlists generated either by hand or by other schematic capture programs. These files usually have a filename extension of ".cir". The ASCII editor used for netlist files supported unlimited file size and unlimited undo/redo. The menu command Tools=>Color Preferences can be used to adjust the colors used in the ASCII editor.

```

Linear Technology LTspice/SwitcherCAD III - [tube.cir]
File Edit View Simulate Tools Window Help
* triode.asc
U1 A 0 0
U2 G 0 0
X1 A G 0 SU3CX300

.dc U1 0 500 1 U2 -50 -10 10

.subckt SU3CX300 A G K
Emu mu 0 VALUE={PWRS(U(G,K),0.98)}
Eshape shape 0 VALUE={{(280+U(G,K))/280}
Egs gs 0 VALUE={LIMIT(U(A,K)+U(G,K)*7.5,0,1E6)}
Egs2 gs2 0 VALUE={PWRS(U(gs)*U(shape),1.5)*135E-6}
Ecath cc 0 VALUE={U(gs2)}
Ga A K VALUE={U(cc)}
Cgk G K 25p
Cga A G 10p
Cak A K 1p
.ends
.end
Run LTspice

```

Efficiency Report

It is possible to obtain an efficiency report from a DC-DC converter from every mode of operation. It is automatically generated in the first two modes, synthesized circuits and application note circuits. After a steady state simulation, an efficiency report will be visible on the schematic as a block of comment text:

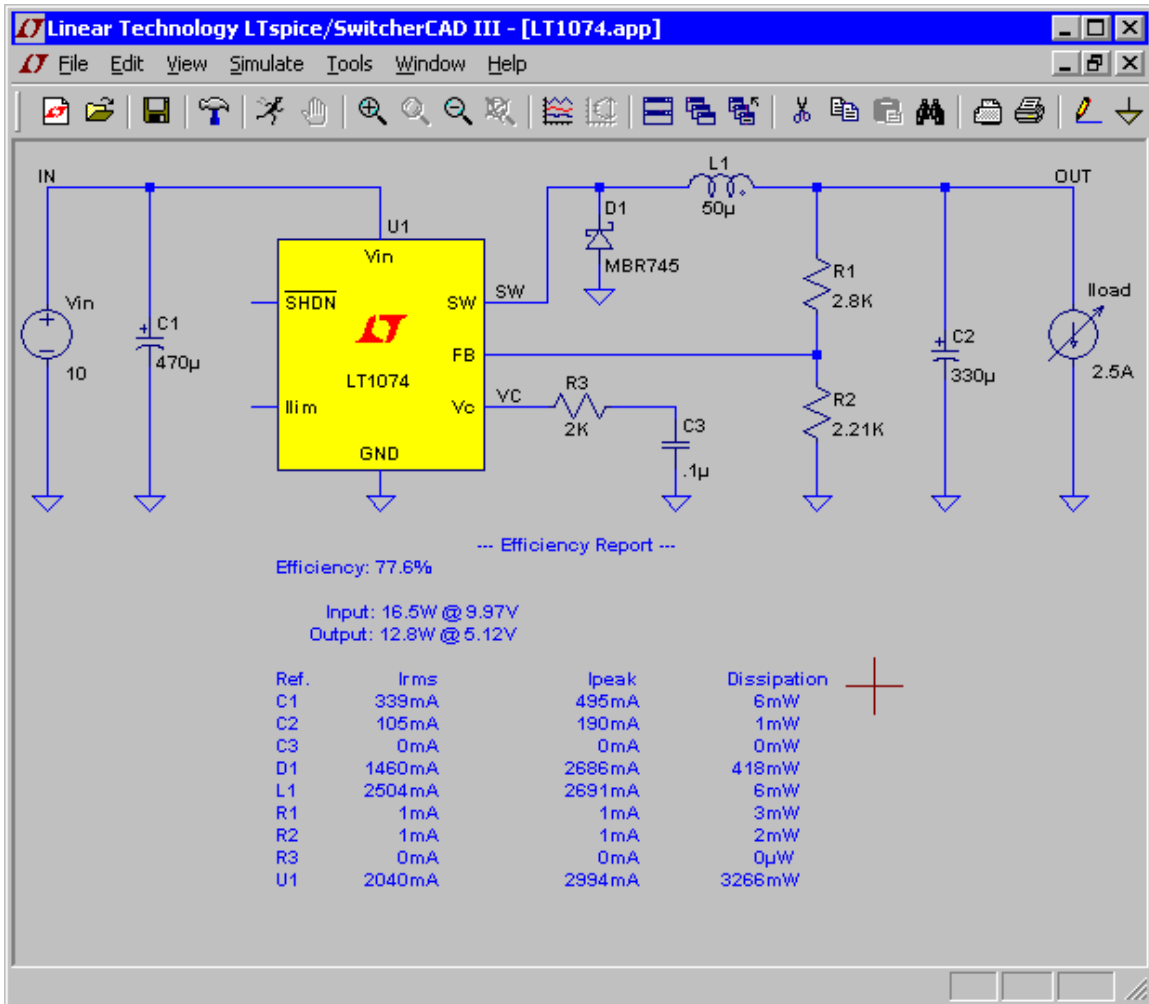

The efficiency of the DC-DC converter is derived in the following manner. In order to identify the input and output, there must be exactly one voltage source and one current source. The voltage source is assumed to be the input while the current source is assumed to be the output. The circuit is run until steady state is sensed by the simulator. This requires the SMPS macro models to be written with information on how to detect steady state. Usually this is detected by noting when the error amp current, averaged over a clock cycle, diminishes to a small value for several cycles. Then at a clock edge, the energy stored in each reactance is noted and the simulation is run for another ten clock cycles but now integrating the dissipation in every device. At the clock edge of the last cycle, the energy stored in every reactance is noted again and the simulation is stopped. The efficiency is reported as the ratio of output power delivered to the load by the

input power sourced by the input voltage after making an adjustment for the change in energy stored in the reactances. Since the dissipation of each device was also noted, it is possible to look how close the energy checksum is to zero.

You can usually compute efficiency of SMPS circuits you draft yourself by using checking the "Stop simulating if steady state is detected" on the Edit Simulation Command editor. After the simulation, use the menu command View=>Efficiency Report.

Automatic detection of steady state doesn't always work. Sometimes the criteria for steady state detection is too strict and sometimes too lenient. You then either adjust the option parameter sstol or simply interactively set the limits for the efficiency integration.

Schematic Capture

Basic Schematic Editing

The schematic capture program is used to create new schematics or modify the example circuits provided. The circuit size and depth of hierarchy is limited only by computer resources.

The program ships with approximately 800 symbols. These symbols cover most of LTC's power ICs, opamps, comparitors, and many general-purpose devices for circuit design. You can also draw your own symbols for devices you wish to import into the program.

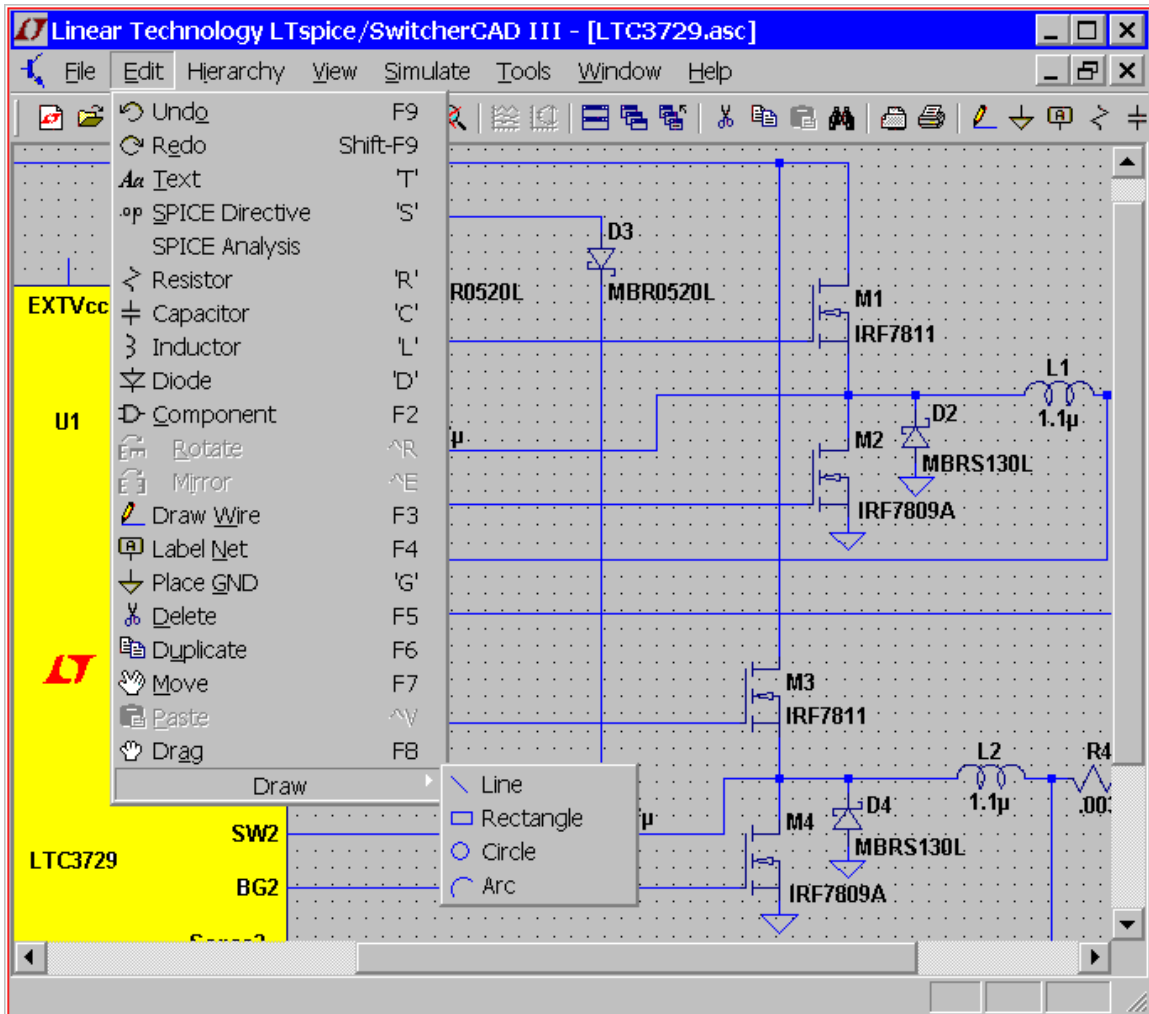

Unlike many schematic capture programs, this one was written explicitly for running SPICE simulations. This means that if you click on an object, the default behavior is to plot the voltage on that wire or current through that component, not select the object for editing or some other editing behavior which would then invalidate the simulation just performed. Hence, when you wish to move, drag or delete objects, first select the move, drag or delete command. Then you can select an object by clicking on it. You can select multiple objects by dragging a box about them. The program will stay in the move, drag, or delete mode until the right mouse button is clicked or the Esc key is pressed. All schematic edits can be undone or redone.

Undo: Undo the last command.

Redo: Redo the last Undo command.

Text: Place text on the schematic. This merely annotates the schematic with information. This text has no electrical impact on the circuit.

SPICE Directive: Place text on the schematic that will be included in the netlist. This lets you mix schematic capture with a SPICE netlist. It lets you set simulation options, include files that contain models, define new models, or use any other valid SPICE commands. You can even use it to run a subcircuit that you don't have a symbol for by stating an instance of the model (a SPICE command that begins with and 'X') on the schematic and including the definition.

SPICE Analysis: Enter/edit the simulation command. This command is not available for circuits run directly from the synthesizer. You must first save the circuit with a ".asc" file extension and then reopen it to edit the simulation command.

Resistor: Place a new resistor on the schematic.

Capacitor: Place a new capacitor on the schematic.

Inductor: Place a new resistor on the schematic.

Diode: Place a new diode on the schematic.

Component: Place a new component on the schematic. The command brings up a dialog that lets you browse and preview the symbol database. This is a more general form of the Resistor, Capacitor, Inductor, and Diode commands.

Rotate: Rotate the sprited objects. Note this is greyed out when there are no objected sprited.

Mirror: Mirror the sprited objects. Note this is greyed out when there are no objected sprited.

Draw Wire: Click the left mouse button to start a wire. Each mouse click will define a new wire segment. Click on an existing wire segment to join the new wire with an existing one. Right click once to cancel the current wire. Right click again to quit this command. You can draw wires through components such as resistors. The wire will automatically be cut such that the resistor is now in series with the wire.

Label Net: Specify the name of a node so an arbitrary one isn't generated by the netlister for this node.

Place GND: Place a GROUND symbol. This is node "0", the global circuit common.

Delete: Delete objects by clicking on them or dragging a box around them.

Duplicate: Duplicate objects by clicking on them or dragging a box around them. You can copy from one schematic to another if they are both opened in the same invocation of LTspice/SwitcherCAD III. Start the Duplicate command in the window of the first schematic. Then make the second schematic the active window and type Ctrl-V.

Move: Click on or drag a box around the objects you wish to move. Then you can move those objects to a new location.

Paste: It is enabled in a new schematic window when objects were already selected with the 'Duplicate' command.

Drag: Click on or drag a box around the objects you wish to drag. Then you can move those objects to a new location and the attached the wires are rubber-band with the new location.

Draw=>Line: Draw a line on the schematic. Such lines have no electrical impact on the circuit, but can be useful for annotating the circuit with notes.

Draw=>Rectangle: Draw a rectangle on the schematic. This rectangle has no electrical impact on the circuit, but can be useful for annotating the circuit with notes.

Draw=>Circle: Draw a circle on the schematic. This circle has no electrical impact on the circuit, but can be useful for annotating the circuit with notes.

Draw=>Arc: Draw an arc on the schematic. This arc has no electrical impact on the circuit, but can be useful for annotating the circuit with notes.

Label a node name

Each node in the circuit requires a unique name. You can specify the name of a node so an arbitrary one isn't generated by the netlister. Node "0" is the circuit global ground and is drawn with a special graphical symbol instead of the name "0".

There is also a graphical symbol defined for node "COM", but this node has no special significance. That is, it's not the SPICE global common and it's not even a global node. It's just sometimes convenient to have a graphical symbol associated with a node distinct from ground.

If you give a node a name starting with the characters "\$G_"; as in for example, "\$G_VDD"; then that node is global no matter where the name occurs in the circuit hierarchy.

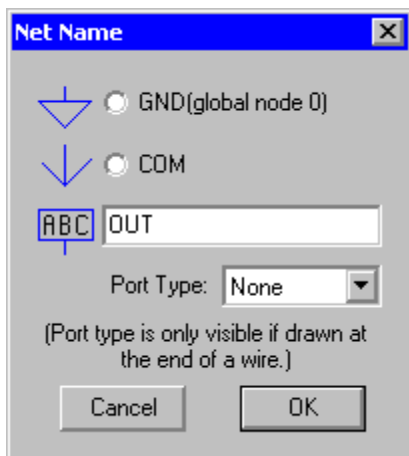

It is possible to indicate that a node is a port of type input, output, or bi-directional. These port types will be drawn differently but have no significance to the netlister. Indicating a port type can make circuit more readable. Global nodes are also drawn differently in that a box is drawn around the name.

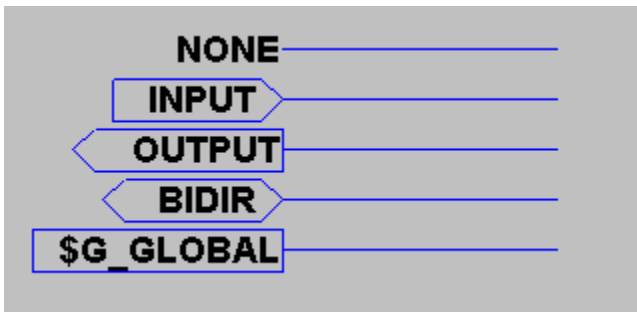

Schematic Colors

The menu command Tools=>Color Preferences colors allows you to set the colors used in displaying the schematics. You click on an object in the sample schematic and use the red, green and blue sliders to adjust the colors to your preferences.

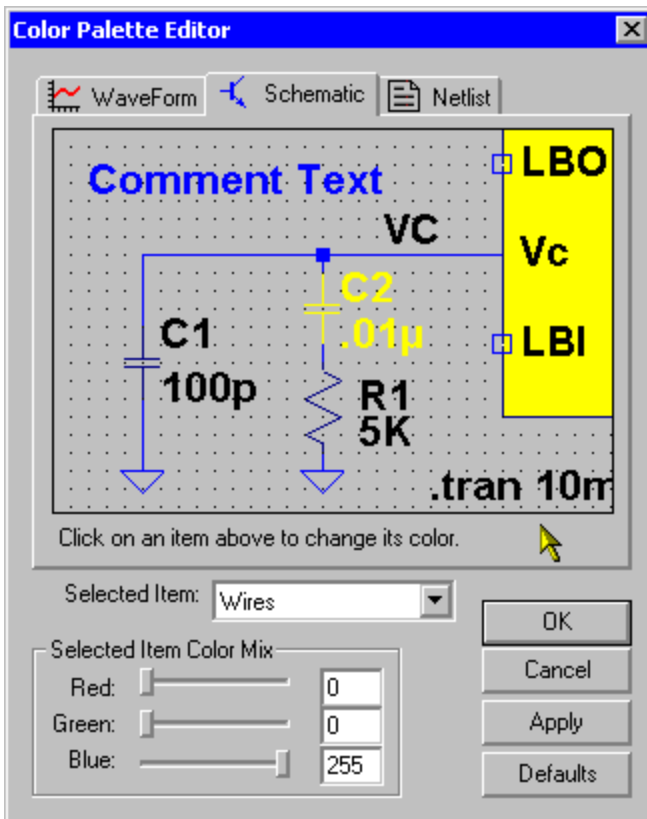

Placing New Components

Certain frequently used components; such as resistors, capacitors, and inductors; can be selected for placing on the schematic with a toolbar button.

For most symbols, use the menu command Edit=>Component to start a dialog to browse for the device you wish.

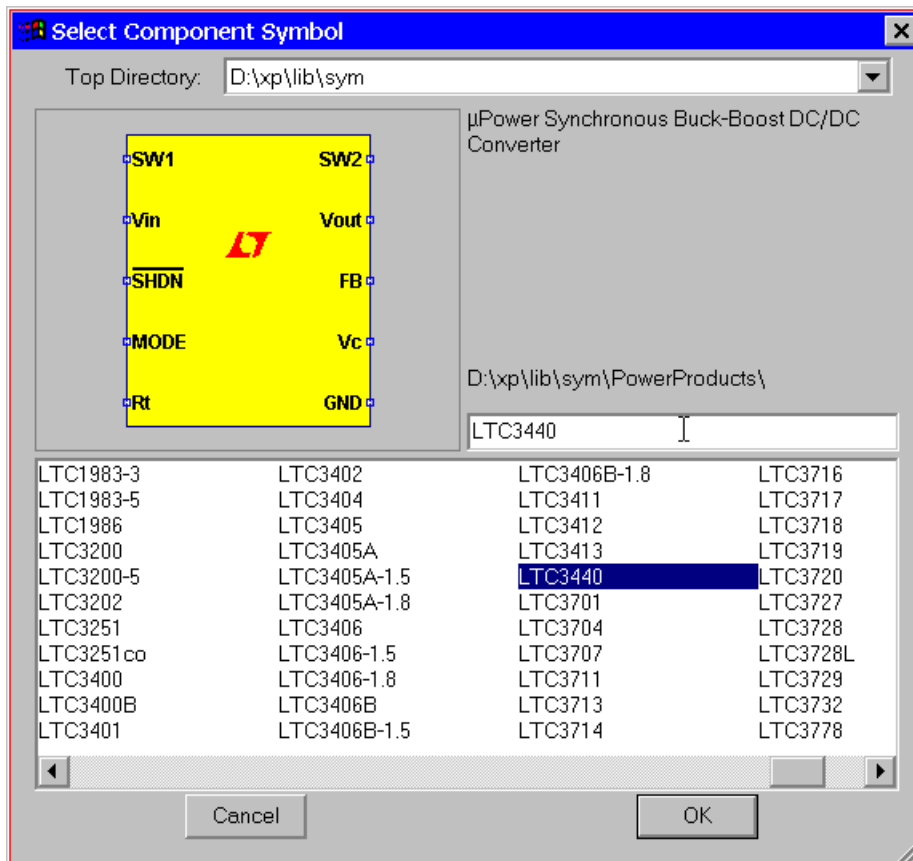

Programming Keyboard Shortcuts

The menu command Tools=>Control Panel=>Drafting Options=>Hot Keys allows you to program the keyboard shortcuts for most commands. Simply mouse click on a command and then press the key or key combination you would like to code for the command.

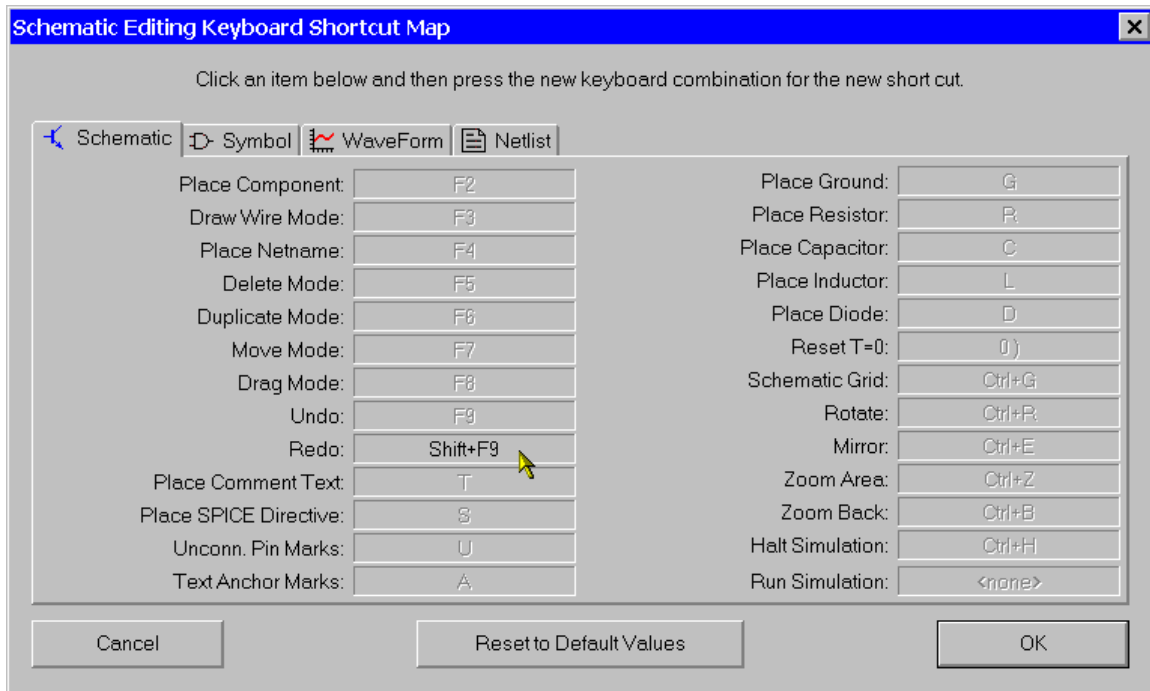

PCB Netlist Extraction

The schematic menu command Tools=>Export Netlist allows you to generate the ASCII netlist for PCB layout. Note that you would have to make a set of symbols that have the same order of pin netlist order. For example, if you want to import an LTspice schematic's netlist into ExpressPCB you would have to make a set of symbols for either LTspice or ExpressPCB that had the same netlist order for every symbol you use. Otherwise diodes could netlist backwards or transistor lead connections could be scrambled.

The following formats are available: Accel, Algorex, Allegro, Applicon Bravo, Applicon Leap, Cadnetix, Calay, Calay90, CBDS, Computervision, EE Designer, ExpressPCB, Intergraph, Mentor, Multiwire, PADS, Scicards, Tango, Telesis, Vectron, and Wire List.

Editing Components

Editing Components

Components can be edited in two or three different ways, depending on the type of component:

1. Most visible component attribute fields can be edited by pointing at it with the mouse and then right clicking. The mouse cursor will turn into a text caret when it's pointing at the text.
2. Many component types, such as resistors, capacitors, inductors, diodes, bipolar transistors, MOSFET transistors, JFET transistors, independent voltage sources, independent current sources, and hierarchical circuit blocks have special editors. These editors can access the appropriate database of devices. To use these editors, right mouse click on the body of the component.
3. Place the mouse over a symbol, hold down the control key, and click the right mouse button. A dialog box will appear that will display all available symbol attributes. Next to each field is a check box to indicate if the field should be visible on the schematic.

Edit a visible attribute

Most visible component attribute fields can be edited by pointing at it with the mouse and then right clicking. The mouse cursor will turn into a text caret when it's pointing at the text. This is a convenient way of changing the value of a component.

|

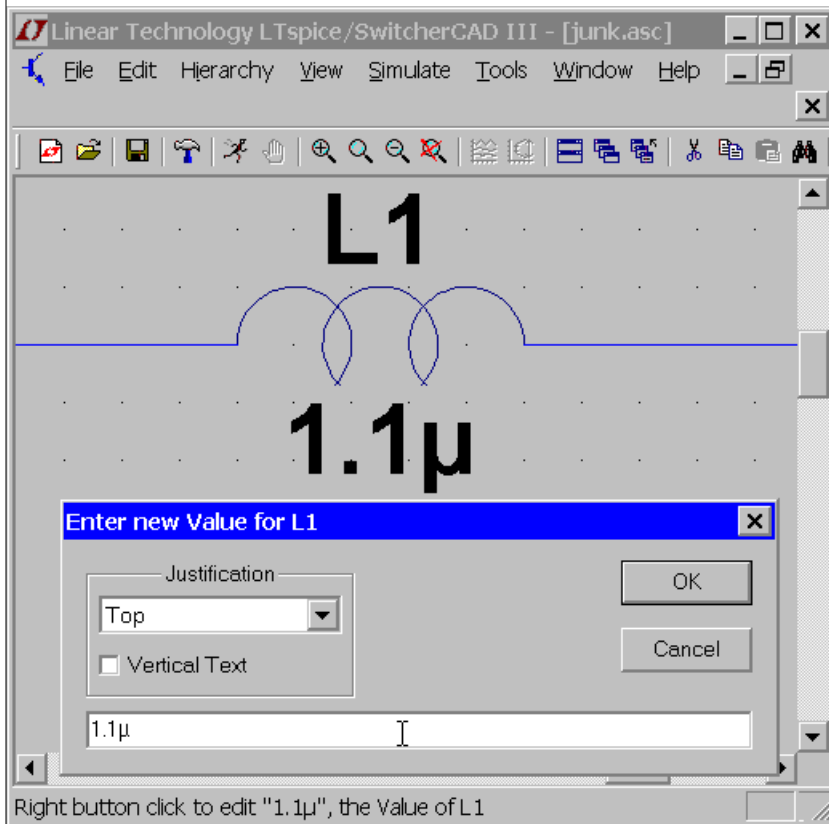

Specialized Component Editors

Many component types, such as resistors, capacitors, inductors, diodes, bipolar transistors, MOSFET transistors, JFET transistors, independent voltage sources, independent current sources, and hierarchical circuit blocks have special editors. These editors can access the appropriate database of related components. To use these editors, right mouse click on the body of the component.

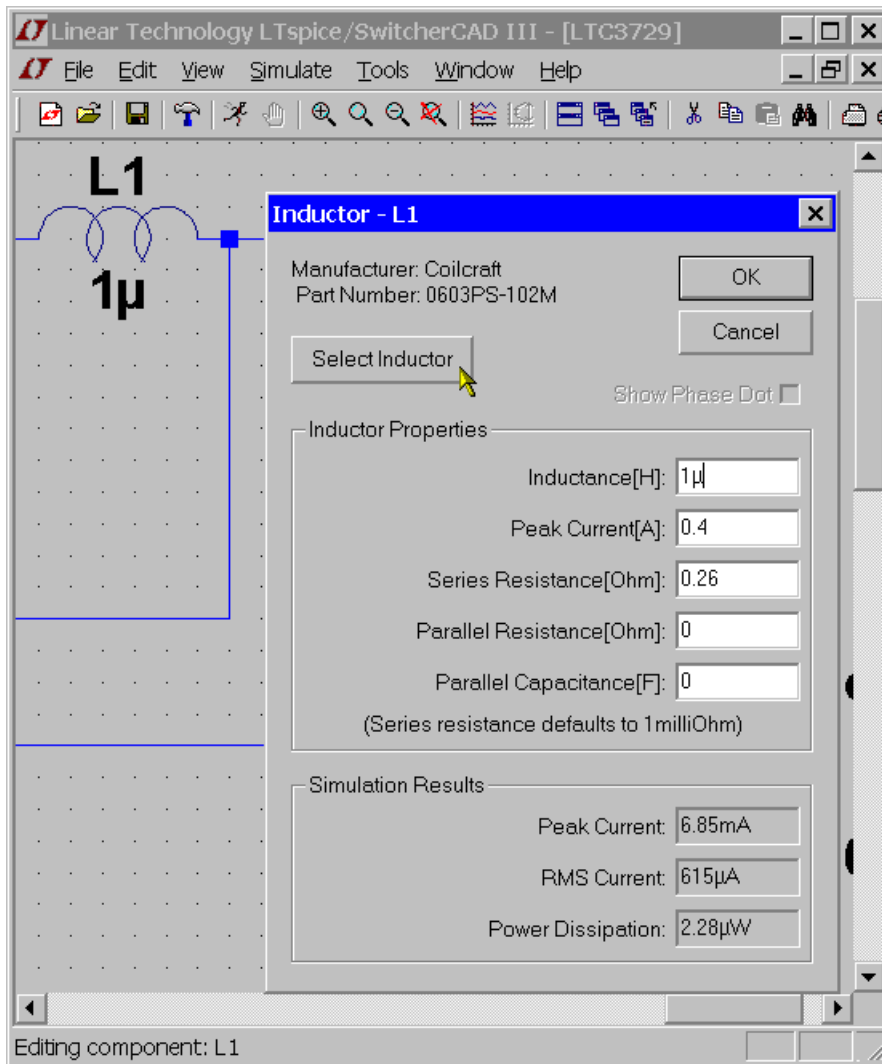

General Attribute Editor

Sometimes it is desired to get direct access to every available component attribute to edit their contents and visibility. An editor that allows you to do this can be reached by placing the mouse over the body of a symbol, hold down the control key, and click the right mouse button. A dialog box will appear that will displays all available symbol attributes. Next to each field is a check box to indicate if the field should be visible on the schematic.

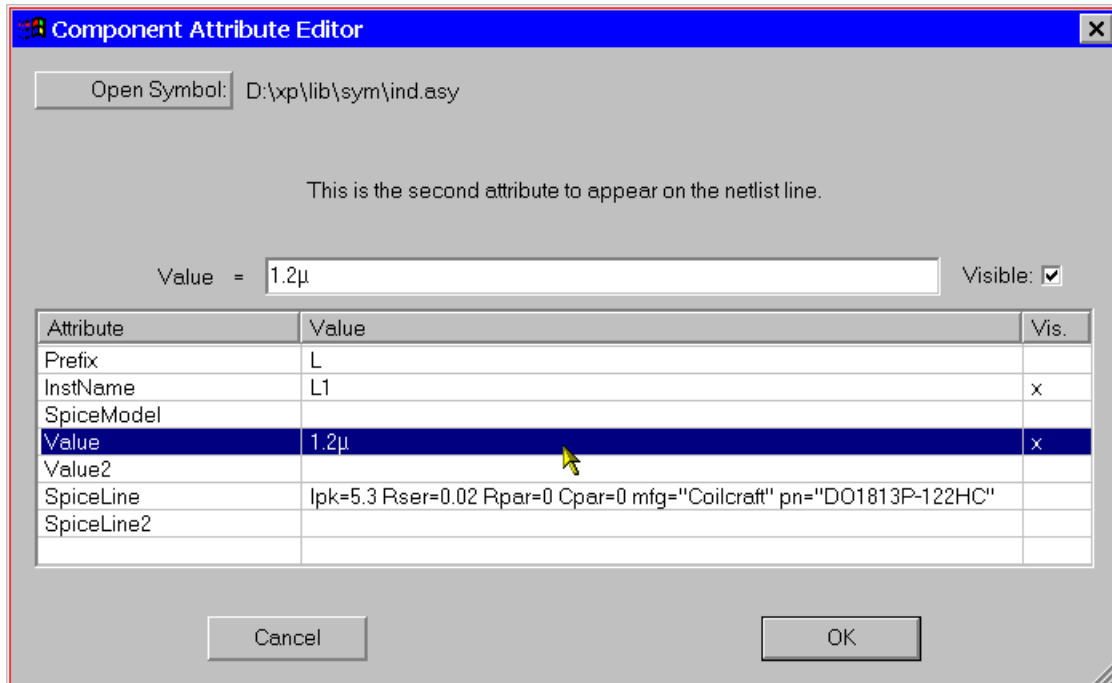

The attributes SpiceModel, Value, Value2, SpiceLine, and SpiceLine2 are all part of the overall value of the component. In terms of the way the component is netlisted for SPICE, the component will generate a line of SPICE that looks like this:

```
<name> node1 node2 [...] <SpiceModel>
+   <Value> <Value2> <SpiceLine> <SpiceLine2>
```

The prefix attribute character is prefixed to the reference designator if different than the first character of the reference designator.

There are two exceptions to the above rule. There is one special symbol, jumper, that does not translate into a circuit element, but is a directive to the netlist generator that there are two different names for the same electrically identical node. The other exception is a symbol defined to have a prefix of 'X' and both a Value and Value2 attributes defined. Such a component netlists as two lines of SPICE:

```
.lib <SpiceModel>  
<name> node1 node2 [...] <Value2>
```

This allows symbols to be defined that automatically include the library that contains the definition of the subcircuit called by the component. The netlist compiler removes duplicate .lib statements. Note that such components are not editable on the schematic.

Creating New Symbols

Symbol Editing Overview

Symbols can represent a primitive device such as a resistor or a capacitor; a subcircuit libreried in a separate file; or another page of the schematic. This section describes how to define your own new symbols. To start a new symbol, use the menu command File=>New Symbol.

NOTE: Screen updates during symbol editing can be slow. If this is a problem with your video card, reduce the area of the symbol-editing window to speed up screen redraws and/or reduce the screen's color resolution. This will give better tactical response to mouse movement.

Drawing the body

You draw the body of the symbol as a series of lines, rectangles, circles, and arcs. The objects have no electrical impact on the circuit. You can also draw text on the symbol with the Draw=>Text command that has no impact on the circuit. The anchor points of this objects are drawn with small red circles so you know what to grab when dragging them about. You can toggle the red markers off and on with the menu command View=>Mark Object Anchors

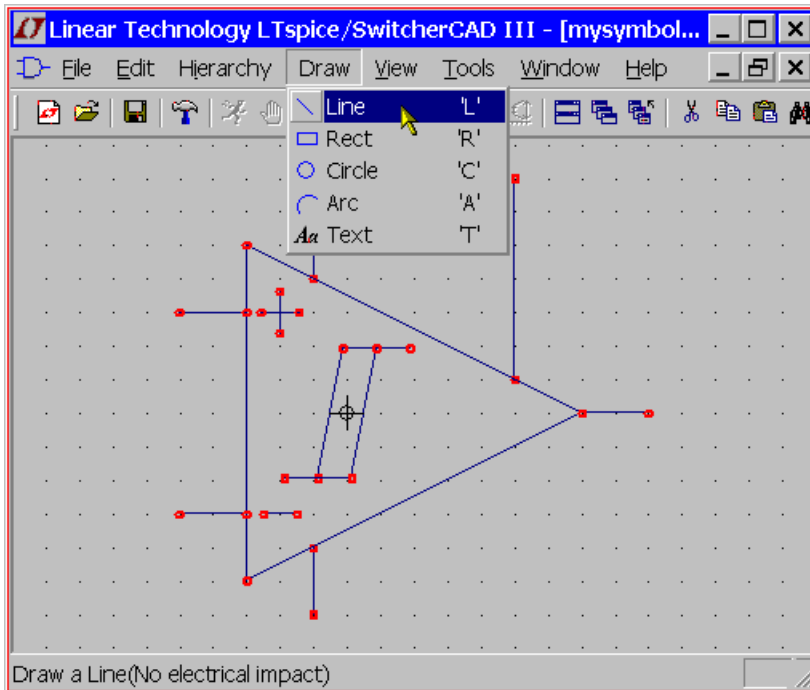

Adding the Pins

The pins allow electrical connection to the symbol. Use the menu command Edit=>Add Pin/Port to add a new pin.

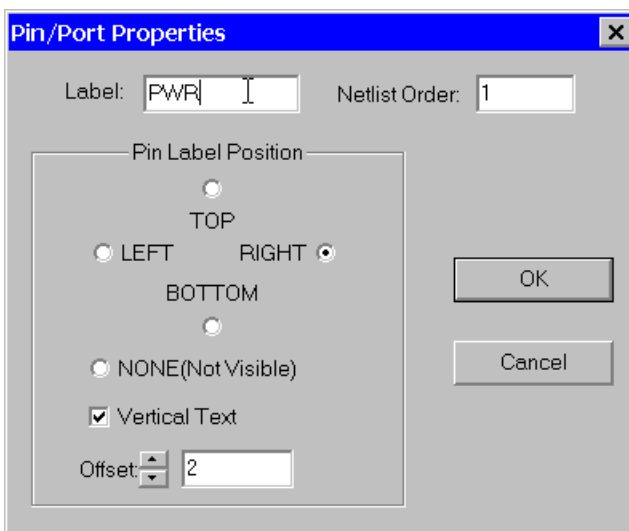

The "Pin Label Position" determines how the pin label is presented. "TOP", "BOTTOM", "LEFT", and "RIGHT" are text justifications. For example, if a pin label is TOP justified, the pin (the label's text justification's anchor point) will be above the label. If the symbol represents a SPICE primitive element or a subcircuit from a library, then the pin label has no direct electrical impact on the circuit. However, if the symbol represents lower-level schematic of a hierarchical schematic, then the pin name is significant as the name of a net in the lower level schematic.

The "Netlist Order" determines the order this pin is netlisted for SPICE.

Adding Attributes

You can define default attributes for a symbol using the menu command Edit=>Attributes=>Edit Attributes. The most important attribute is called the "Prefix". This determines the basic type of symbol. If the symbol is intended to represent a SPICE primitive, the symbol should have the appropriate prefix, R for resistor, C or capacitor, M for MOSFET, etc. See the LTspice reference for a complete set of SPICE primitives available. The prefix should be 'X' if you want to use the symbol to represent a subcircuit defined in a library.

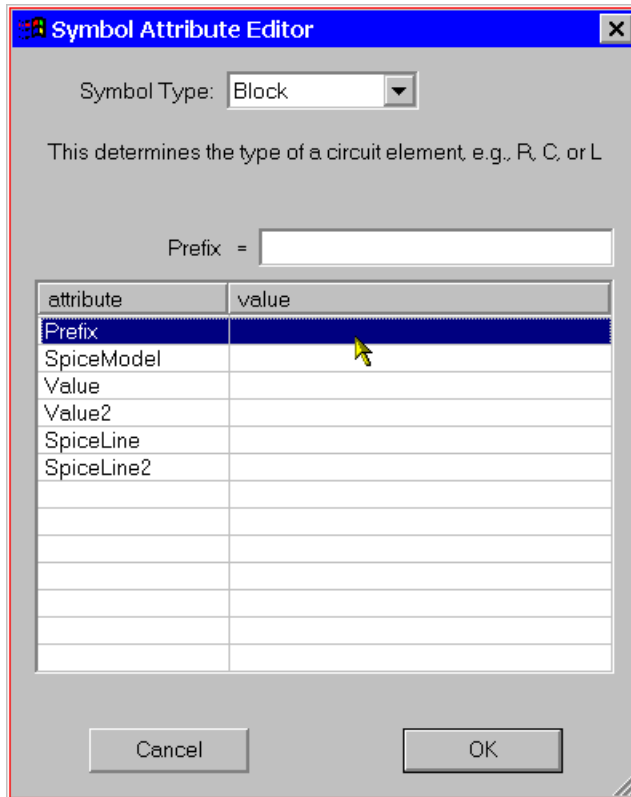

The symbol's attributes can be overridden in the instance of the symbol as a component in a schematic. For example, if you have a symbol for a MOSFET with a prefix attribute of 'M', it's possible to override the prefix to an 'X' on an instance-by-instance basis so that the transistor can be modeled as subcircuit instead.

There is a special combination of attributes that will cause a required library to be automatically included in every schematic that uses the symbol:

Prefix: X

SpiceModel: <name of file including the spicemodel>

Value: <What ever you want visible on the schematic>

Value2: <The value as you want in the netlist>

Value2 would be made to coincide with a subcircuit name defined in the file including the spicemodel and may pass additional parameters to the subcircuit. When a symbol is defined in this manner, an instance of the symbol as a component on a schematic cannot be edited to have different attributes.

If you wish the symbol to represent another page of a hierarchical schematic, all attributes should be left blank the symbol type should be changed from "Cell" to "Block". No attribute values need be set.

There is a symbol attribute, ModelFile, that may be specified. This is used for the name of a file to be included in the netlist as a library. See the symbol/subcircuit pair `.\lib\sym\Opamps\lpole.asy` and `.\lib\sub\lpole.sub` to see an example of the utility of this attribute. If the prefix attribute is 'X' and there is a symbol attribute SpiceModel defined that is subcircuit defined in the model file, then a drop list of all subcircuits names will be available when an instance of the symbol is edited on a schematic.

Attribute Visibility

You can edit the visibility of attributes using the menu command `Edit=>Attributes=>Attribute Window`. After you select an attribute with this dialog you will then be able to position it as you wish with respect to the symbol.

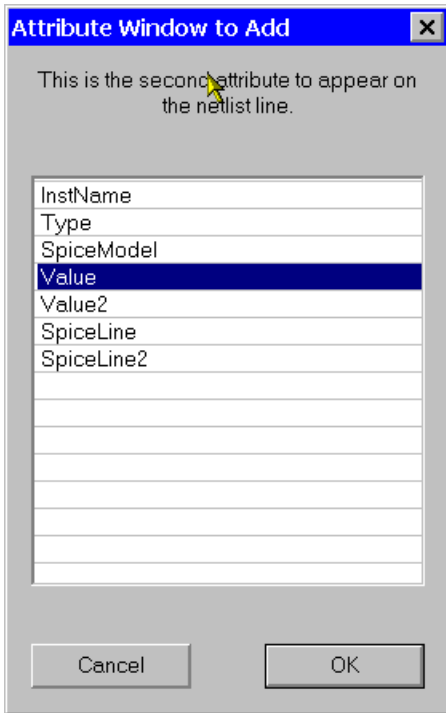

You can modify the text justification and contents of attributes that you've already made visible by right mouse clicking on the text of the attribute.

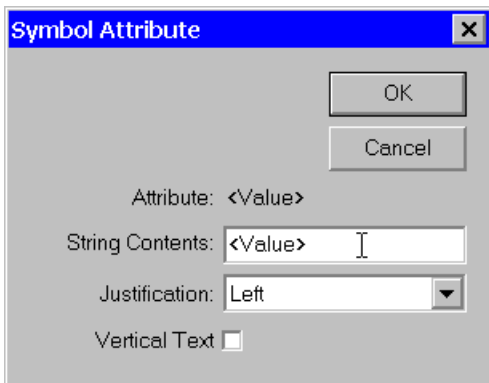

Hierarchy

Hierarchy Overview

Hierarchical schematic drafting has powerful advantages. Much larger circuits can be drafted than can fit onto a one

sheet schematic while retaining the clarity of the smaller schematics. Repeated circuitry to be easily handled in an abstract manner. Blocks of circuitry can be libreried for latter use in a different project.

Rules of Hierarchy

The way to refer to another schematic as a block in a higher level schematic is to create a symbol with the same name as the block schematic and then by placing that symbol on the higher level schematic. For example, if you have a top-level schematic called topXYZ.asc and another schematic file called preamp.asc that you wish to place in the schematic of topXYZ then create a symbol called preamp.asy and place an instance of that symbol on the schematic of topXYZ. The electrical connectivity between the schematics is established by connecting wires of the higher-level schematic to pins on the lower level block's symbol that matches the name of a node in the lower-level schematic.

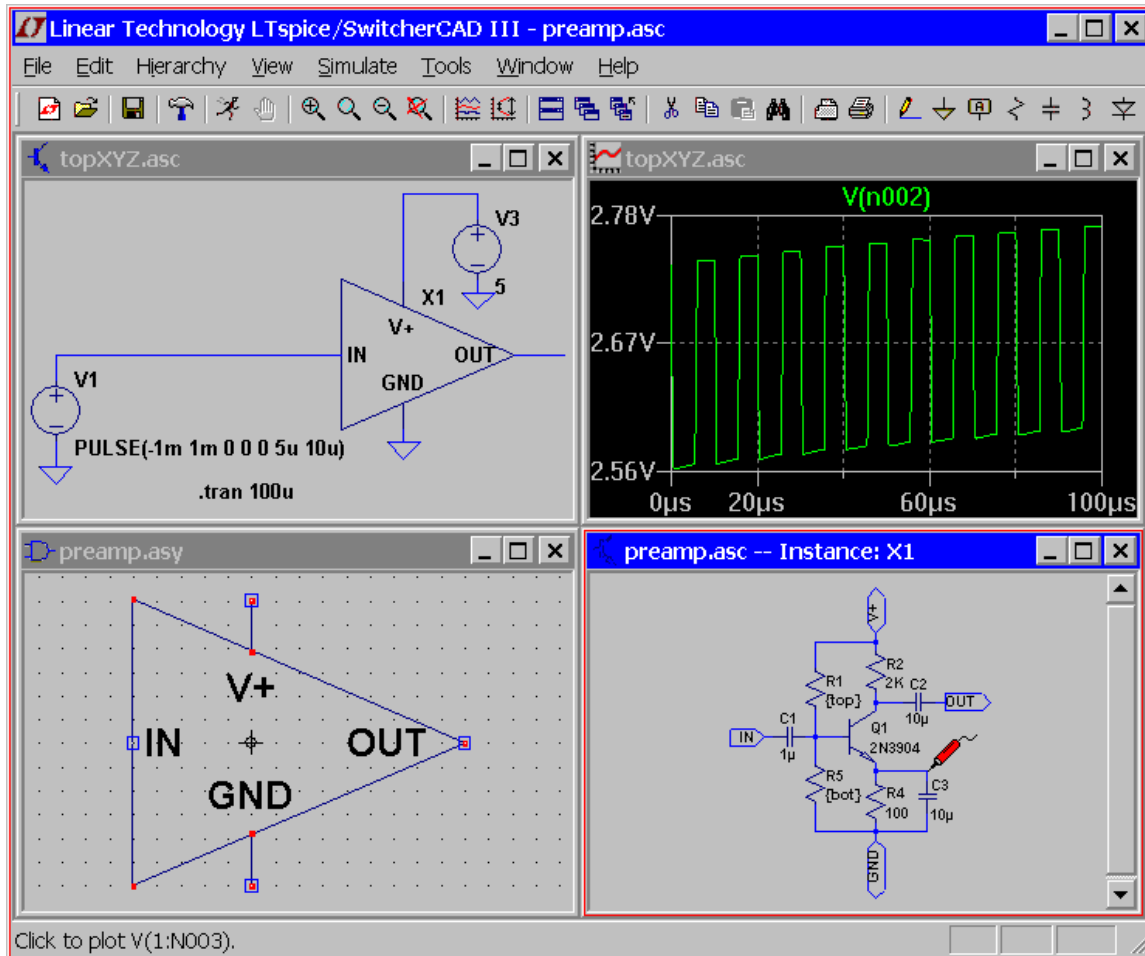

LTspice will look in the directory of the top-level schematic for symbols and blocks to complete the circuitry of the top-level schematic.

The symbol you create to represent the lower-level schematic block should have no attributes defined.

Navigating the Hierarchy

Any file opened with the File=>Open command is considered a top-level schematic. You can add SPICE directives to that block and run simulations using only it and any lower-level schematics to which it refers.

To open a schematic block as an instance of a block of a higher-level schematic, first open the higher-level schematic and then move the mouse to the body of the instance of the symbol calling the block. When you right mouse click on the body of the instance of that symbol, a special dialog appears that allows you to open the schematic. When you open the schematic in this manner, you can cross probe the nodes and current in the block. Note that you should have the options "Save Subcircuit Node Voltages" and "Save Subcircuit Device Currents" checked on the Save Defaults Pane of the Control Panel. Also, if you've highlighted a node on the top-level schematic, that node will be also highlighted in the lower level block.

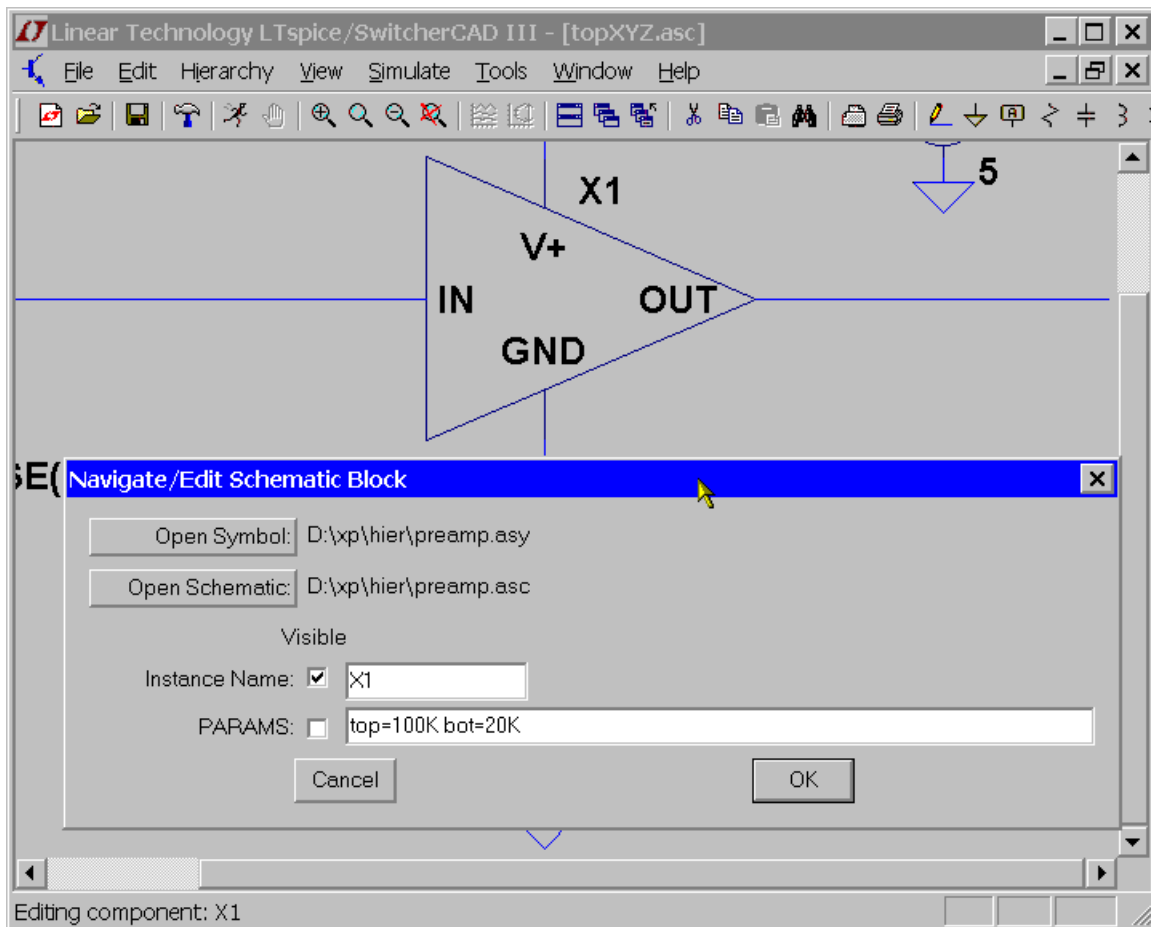

Note that is dialog also allows you to enter parameters to pass to this instance of the circuitry in preamp.asc.

Waveform Viewer

Overview

SwitcherCAD III includes an integrated waveform viewer that allows complete control over the manner the simulation data is plotted.

Trace Selection

There are three basic means of selecting plotted traces.

1. Probing directly from the the schematic
2. Menu command View=>Visible Traces
3. Menu command View=>Add Trace

The undo and redo commands allow you to review the different trace selections plotted no matter which method of selection is used.

1. Probing directly from the the schematic:

The easiest method is to simply probe the schematic. You simply point and click at a wire to plot the voltage on that wire. You plot the current through any component with two connections (like a resistor, capacitor or an inductor) by clicking on the body of the component. This works at any level of the circuit's hierarchy. You can also plot current into a particular connection of a component with more than two pins by clicking on that pin of the symbol. If you click the same voltage or current twice, then all other traces will be erased and the double clicked trace will be plotted by itself. You can delete individual traces by clicking on the trace's label

after selecting the delete command. The following screen shot shows how to point at a pin current. Notice that the mouse cursor turns into an icon that looks like a clamp on ammeter when it's pointing at a plotable current.

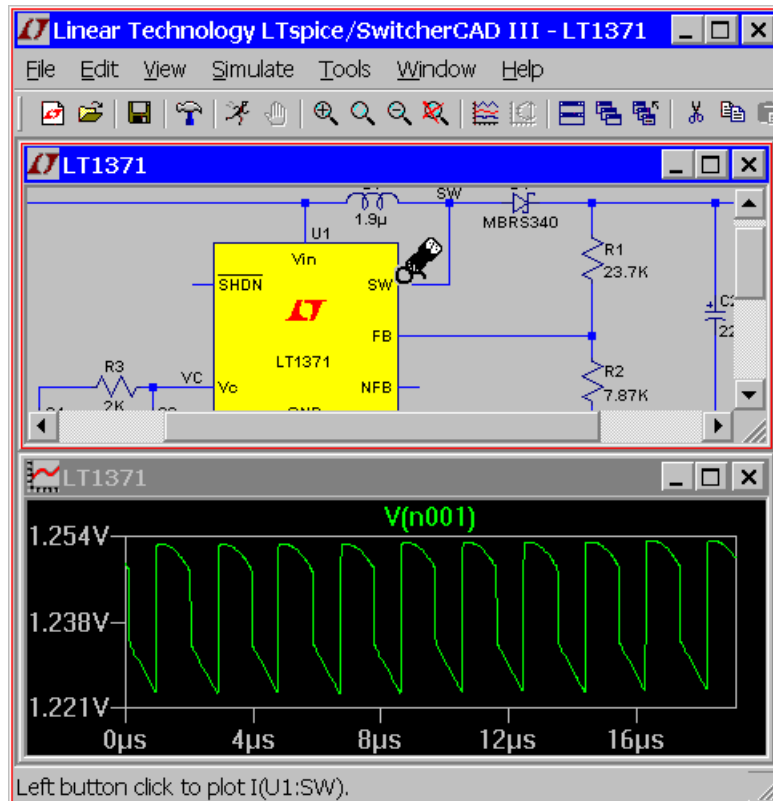

It is also possible to point at voltage differences with the mouse. You can click on one node and drag the mouse to another node. You will see the red voltage probe at the first node and a black probe on the second. This allows you to differentially plot voltages:

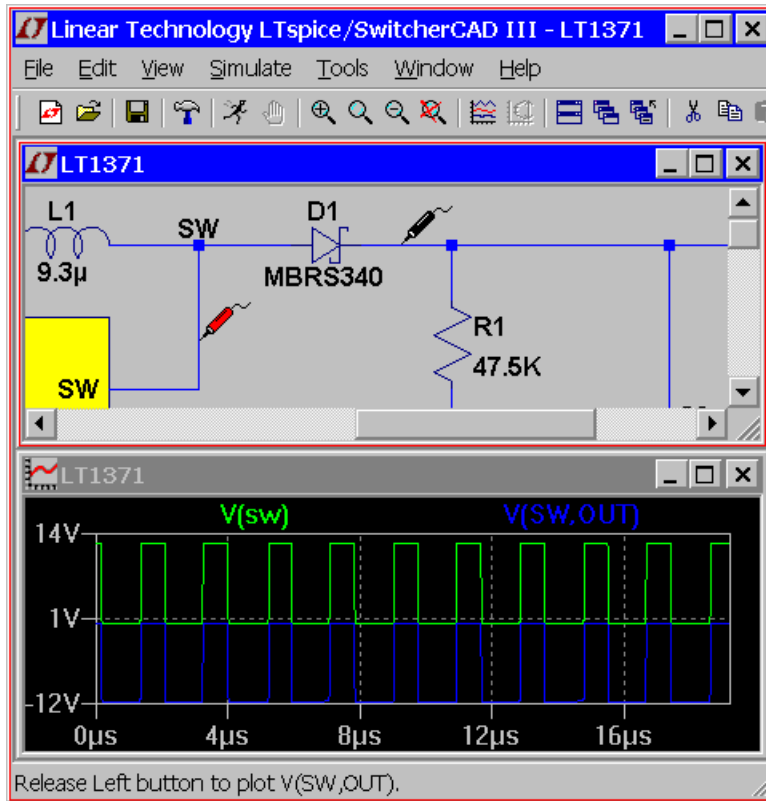

2. Menu command View=>Visible Traces:

The menu command View=>Visible Traces is the dialog seen at the beginning of plotting data from a simulation. It lets you select the initial traces to start the plot. It also gives you random access to the full list of traces plotted.

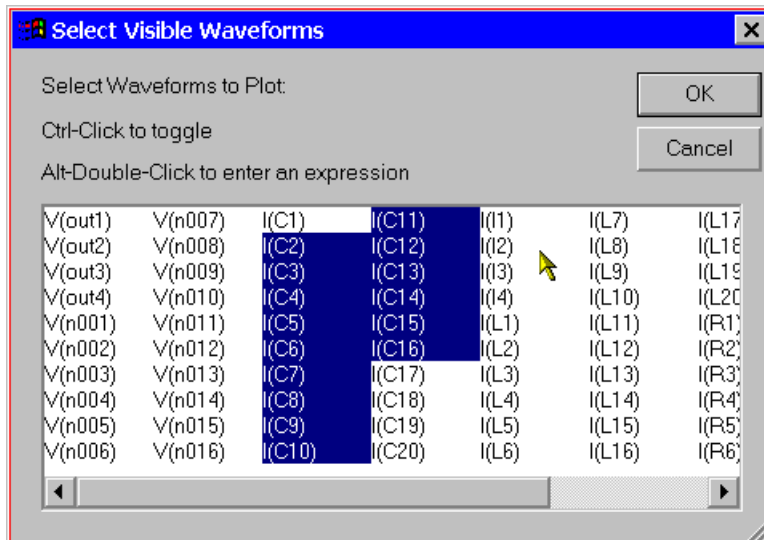

3. Menu command View=>Add Trace:

The View=>Add Trace command is similar to the View=>Visible Traces command. However, you can not delete traces that are already visible with it. It has two useful capabilities. One is an edit box near the top of the dialog that allows you to enter a pattern of characters. Only trace names that match the pattern will be shown in the dialog. This is very useful for finding a trace when you can only partially remember the name. Also, it's a bit easier to compose an expression of trace data because you can click on a name in the dialog instead of typing out its name.

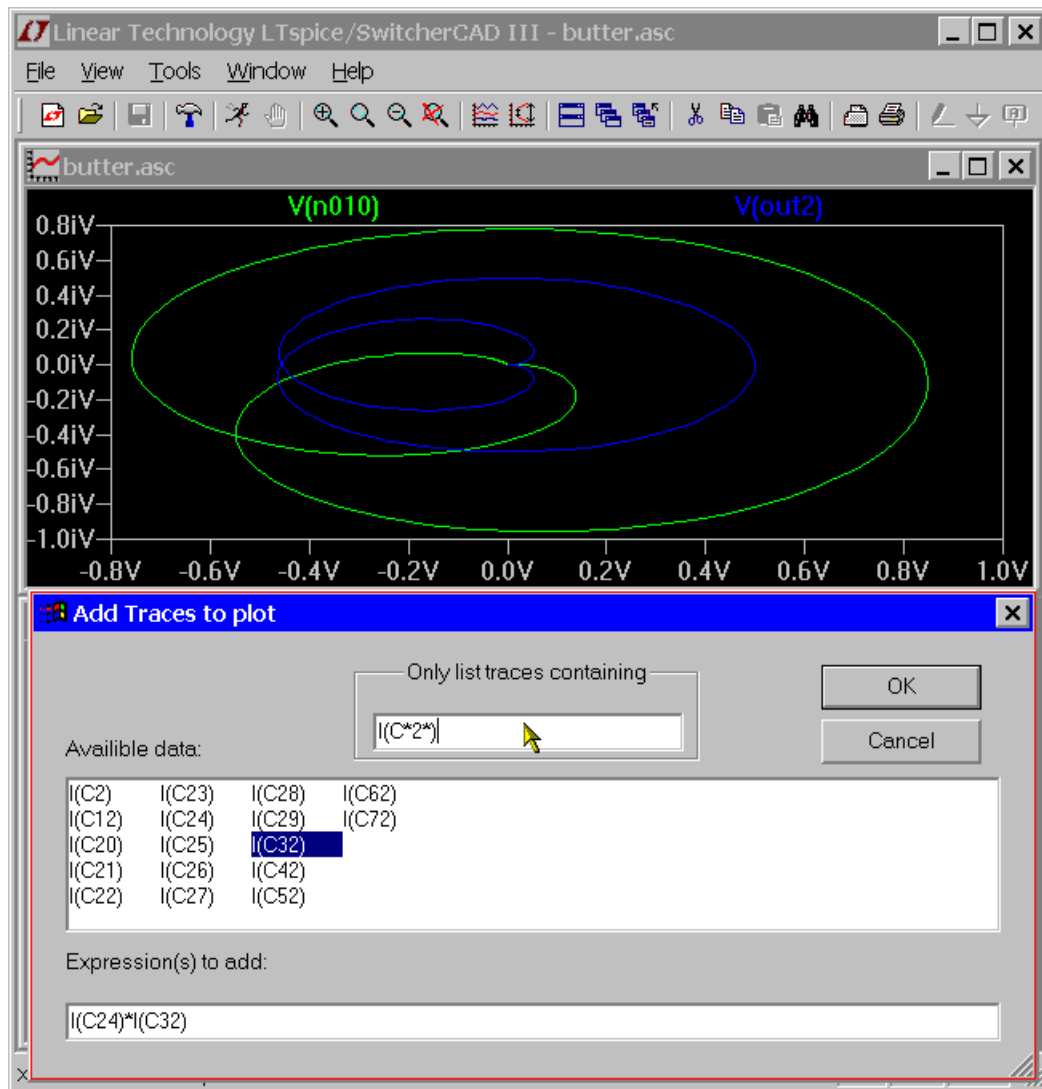

Zooming

LTspice/SwitcherCAD III autozooms whenever there is new data to plot. To zoom up on an area, simply drag a box about the region you wish to see drawn larger.

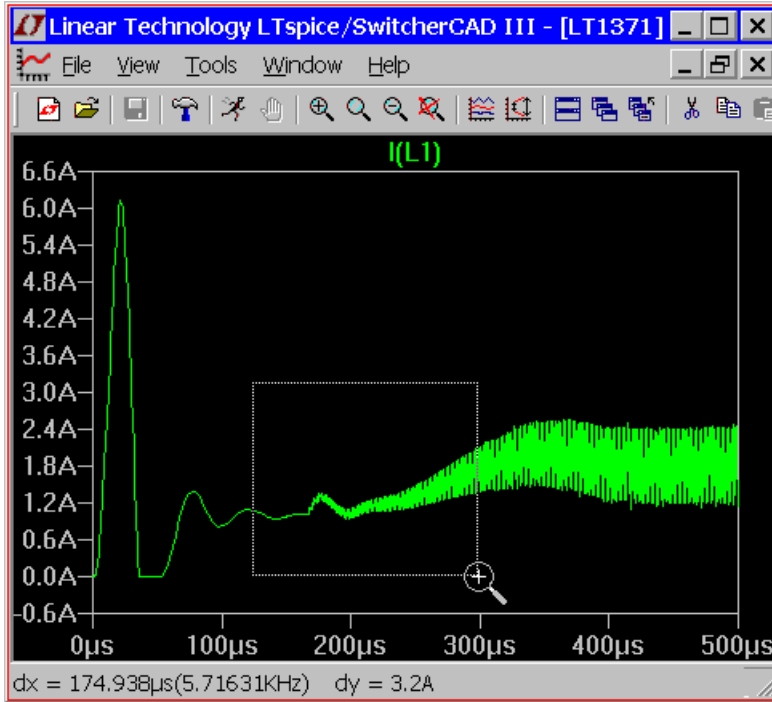

There are toolbar buttons and menu commands for zooming out, panning, and returning to the autoranged zoom. Note the undo and redo commands allow you to review the different zooms used.

Waveform Arithmetic

There are three types of mathematical operations that can be performed on waveform data:

1. Plot expressions of traces.
2. Compute the average or RMS of a trace.

3. Display the Fourier Transform of a Trace.

1. Plot expressions of traces.

Both the View=>Visible Traces and View=>Add Trace commands allow one to enter an expression of data. Another method to plot an expression of available simulation data traces is to move the mouse to the trace's label and right click. This dialog box also allows you to set the trace's color and allows you to select units to associate with the plotted quantity.

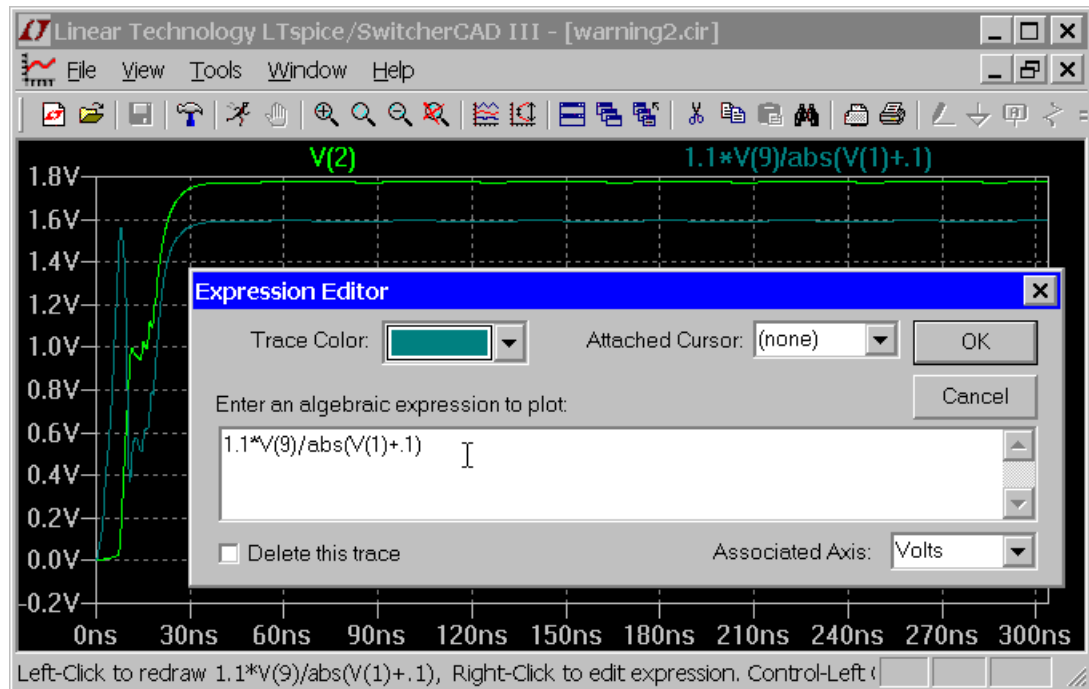

The difference of two voltages; e.g., $V(a)-V(b)$; can equivalently be written as $V(a,b)$. The following functions are available for real data:

name	function
abs(x)	absolute value
acos(x)	arc cosine of x
acosh(x)	arc hyperbolic cosine
asin(x)	arc sine
asinh(x)	arc hyperbolic sine
atan(x)	arc tangent

atan2(y,x)		four quadrant arc tangent of y/x
atanh(x)		arc hyperbolic tangent
cos(x)		cosine
cosh(x)		hyperbolic
exp(x)		exponential
ln(x)		natural logarithm
log(x)		natural logarithm
log10(x)		base 10 logarithm
sgn(x)		sign
sin(x)		sine
sinh(x)		hyperbolic sine
sqrt(x)		square root
tan(x)		tangent
tanh(x)		hyperbolic tangent
u(x)		unit step, 1 if x > 0., else 0.
buf(x)		1 if x > .5, else 0
inv(x)		0 if x > .5, else 1
uramp(x)		x if x > 0., else 0.
int(x)		convert x to integer
floor(x)		integer equal or less than x
ceil(x)		integer equal or greater than x
rand(x)		random number between 0 and 1.
min(x,y)		the less of x or y
max(x,y)		the greater of x or y
limit(x,y,z)		equivalent to min(max(x,y),z)
if(x,y,z)		if x > .5, then y else z
table(x,a,b,...)		interpolate a value for x
		based on a look up table given
		as a set of pairs of points

For complex data, the functions atan2(), sgn(), u(), buf(), inv(), uramp(), int(), floor(), ceil(), rand(), min(), limit(), if(), and table(...) are not available.

The following operations, grouped in reverse order of precedence of evaluation, are available for real data:

symbol	Operation
&	convert the expressions to either side to Boolean, then AND
	convert the expressions to either side to Boolean, then OR

^	convert the expressions to either side to Boolean, then XOR
<	TRUE if expression on the left is less than the expression on the right, otherwise false
>	TRUE if expression on the left is greater than the expression on the right, otherwise FALSE
<=	TRUE if expression on the left is less than or equal the expression on the right, otherwise FALSE
>=	TRUE if expression on the left is greater than or equal the expression on the right, otherwise FALSE
+	addition
-	subtraction
*	multiplication
/	division
**	raise left hand side to power of right hand side
!	convert the following expression to Boolean and invert

TRUE is numerically equal to 1 and FALSE is 0. Conversion to Boolean converts a value to 1 if the value is greater than 0.5, otherwise the value is converted to 0.

For complex data, only +, -, *, /, and ** are available. The Boolean XOR operator, ^ is understood to mean exponentiation, **.

The following constants are also internally defined:

constant	value
e	2.7182818284590452354
pi	3.14159265358979323846
k	1.3806503e-23
q	1.602176462e-19

2. Compute the average or RMS of a trace.

The waveform viewer can integrate a trace to obtain the average and RMS value over the displayed region. First zoom the waveform to the region of interest, then move the mouse to the label of the trace, hold down the control key and left mouse click.

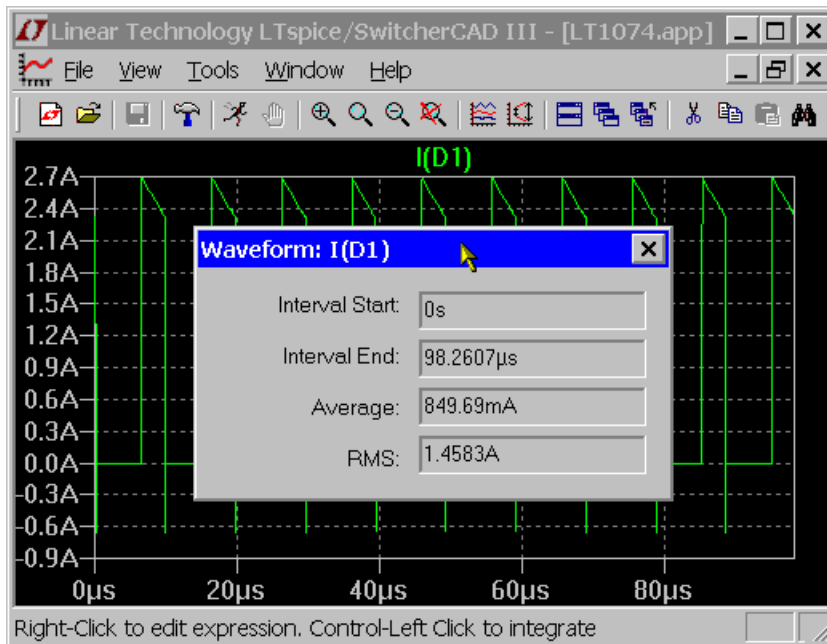

3. Display the Fourier Transform of a Trace.

You can use the menu command View=>FFT to perform a Fast Fourier transform on various data traces.

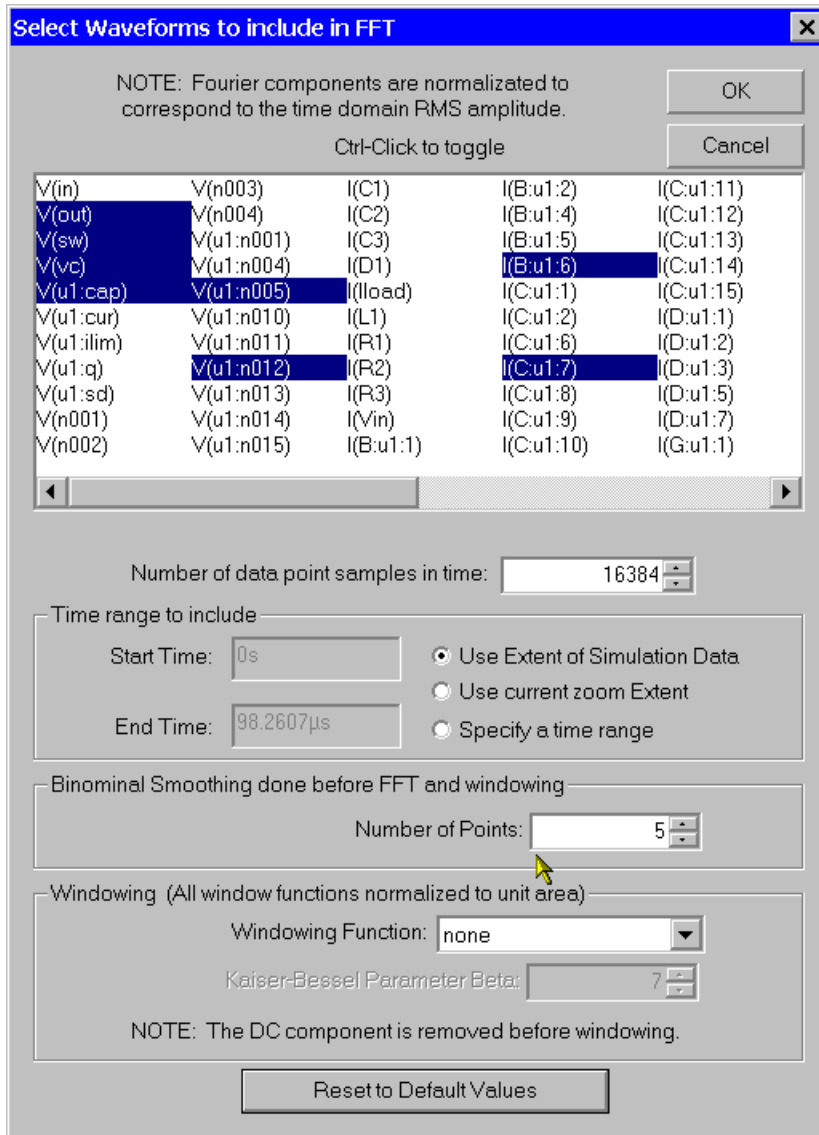

User-Defined Functions

The menu command Plot Settings=>Edit Plot Defs File allows you to enter your own function definitions and parameter definitions for use in the waveform viewer. These functions are kept in the file plot.defs in the same directory as the SwCADIII executable, scad3.exe.

Then syntax is the same as the .param and .func statements used for parameterized circuits. E.g., the line

```
.func Pythag(x,y) {sqrt(x*x+y*y)}
```

defines the function Pythag() to be the square root of the sum of its two arguments.

Similarly, the line

```
.param twopi = 2*pi
```

would define twopi to be 6.28318530717959. Note that it uses the already internally defined constant pi of the waveform viewer.

Axis Control

When you move the mouse cursor beyond the data plotting region, the cursor turns into a ruler. This tries to indicate that you are pointing at that axis' attributes. When you left click you can enter a dialog to manually enter that axis' range and the nature of the plot. For example, for real data, if you move the mouse to the bottom of the screen and left click, you can enter a dialog to change the horizontal quantity plotted. This lets you make parametric plots.

For complex data, you can choose to plot either phase, group delay, or nothing against the right vertical axis. You can change the representation of complex data from Bode to Nyquist or Cartesian by moving the mouse to the left vertical axis of complex data.

Plot Panes

Multiple plot panes can be displayed on one window. This allows better separation between traces and allows different traces to be independently autoscaled. Traces can be dragged between panes by dragging the label. A copy of a trace can be made on another pane by holding down the control key when you release the mouse button.

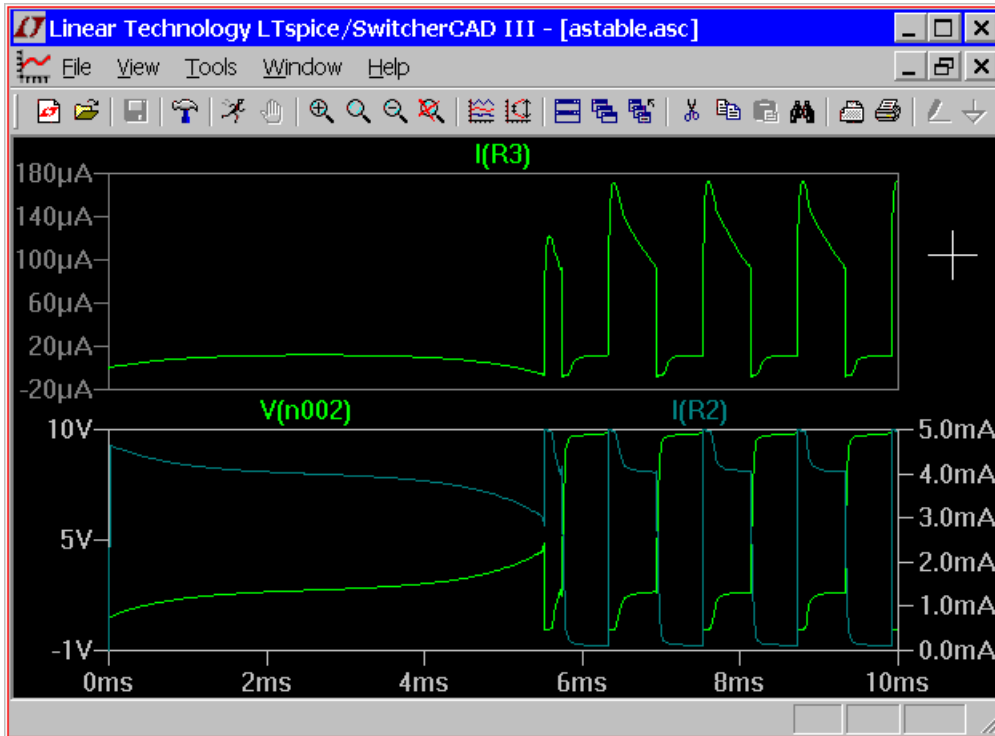

Color Control

The menu command Tools=>Color Preferences colors allows you to set the colors used for plotting data. You click on an object in the sample plot and use the red, green and blue sliders to adjust the colors to your preferences.

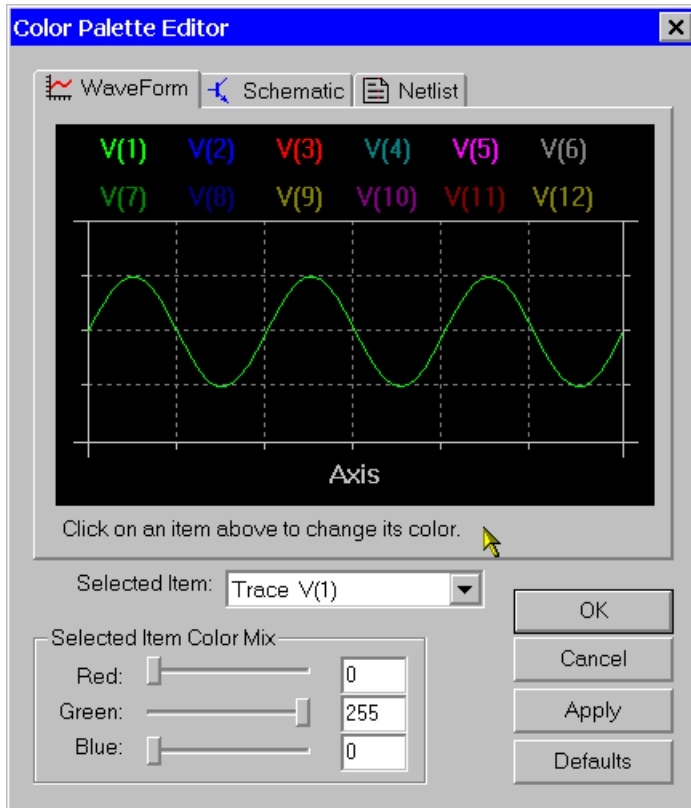

Attached Cursors

There are up to two attached cursors available. You can attach a cursor to a trace by left mouse clicking on the trace label. You can attach both cursors to a single by right clicking on the trace label and selecting "1st & 2nd". The attached cursors can be dragged about with the mouse or moved with the cursor keys.

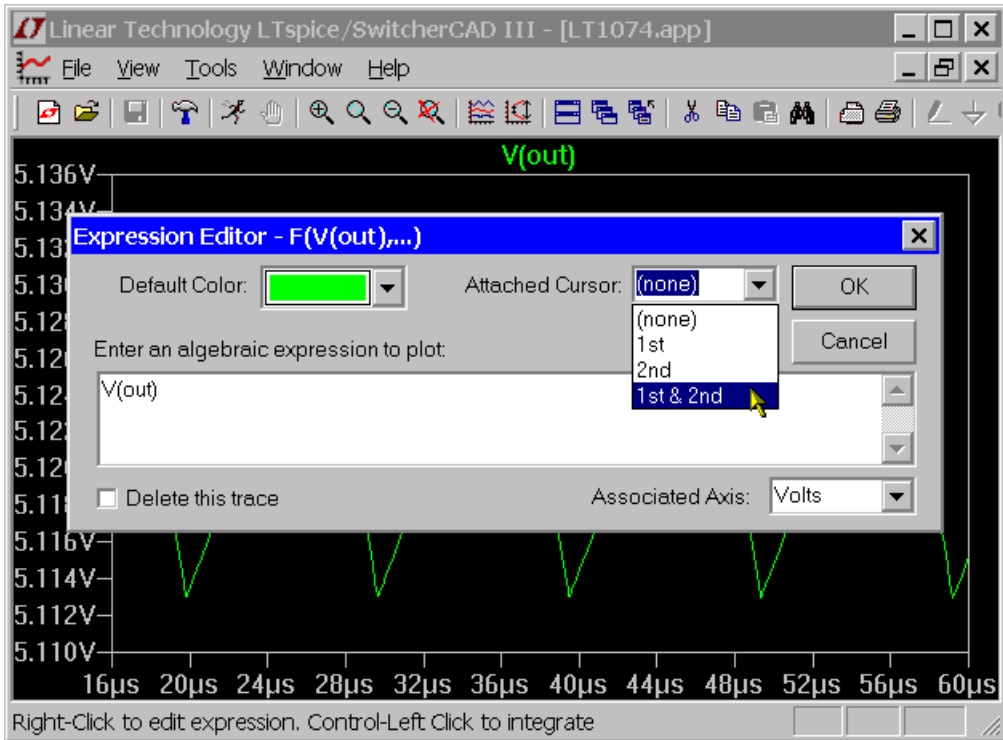

When there are attached cursors active, a readoutdisplay becomes visible that will tell you the location and difference of the cursors.

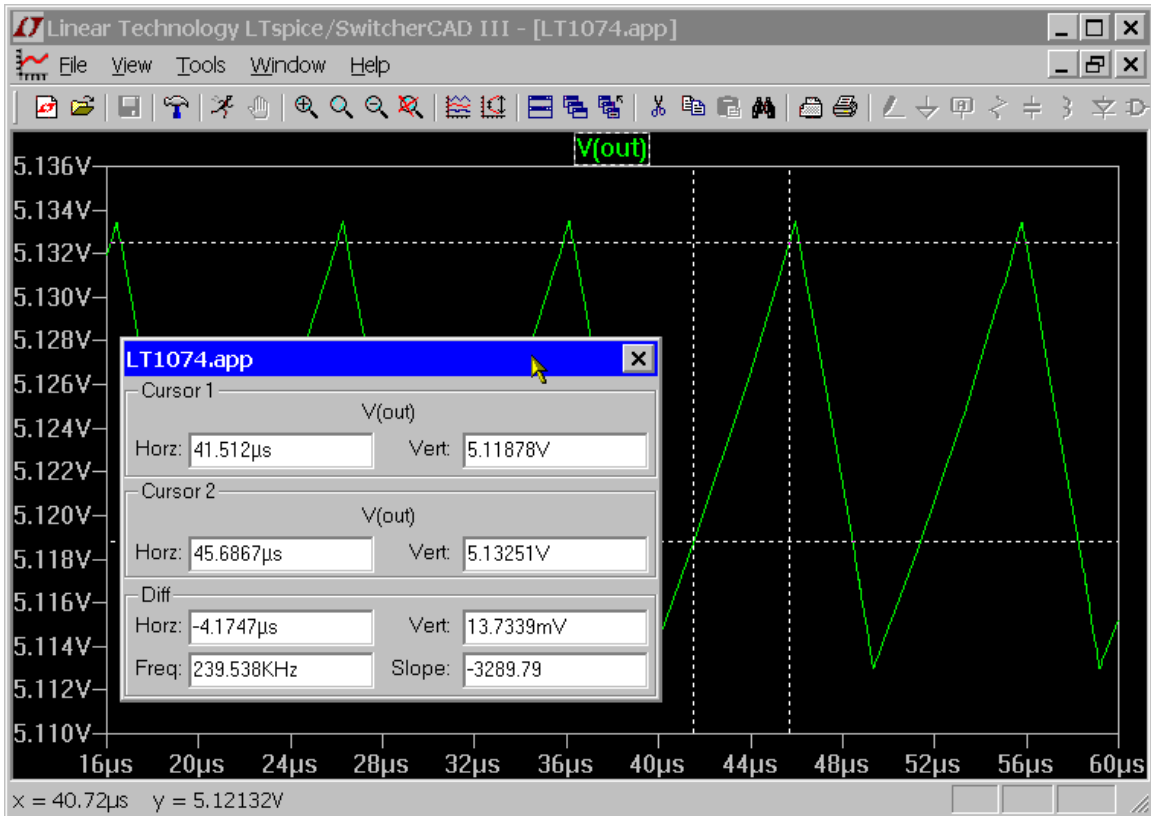

Note that there is also mouse cursor readout independent of the above attached cursor readout. As you move the mouse over the waveform window, the mouse position is readout on the status bar. If you drag the mouse as if you were going to zoom, the size of box is displayed on the status bar. This lets you quickly measure differences with the mouse cursor. If the horizontal axis is time, then this time difference is also converted to frequency.

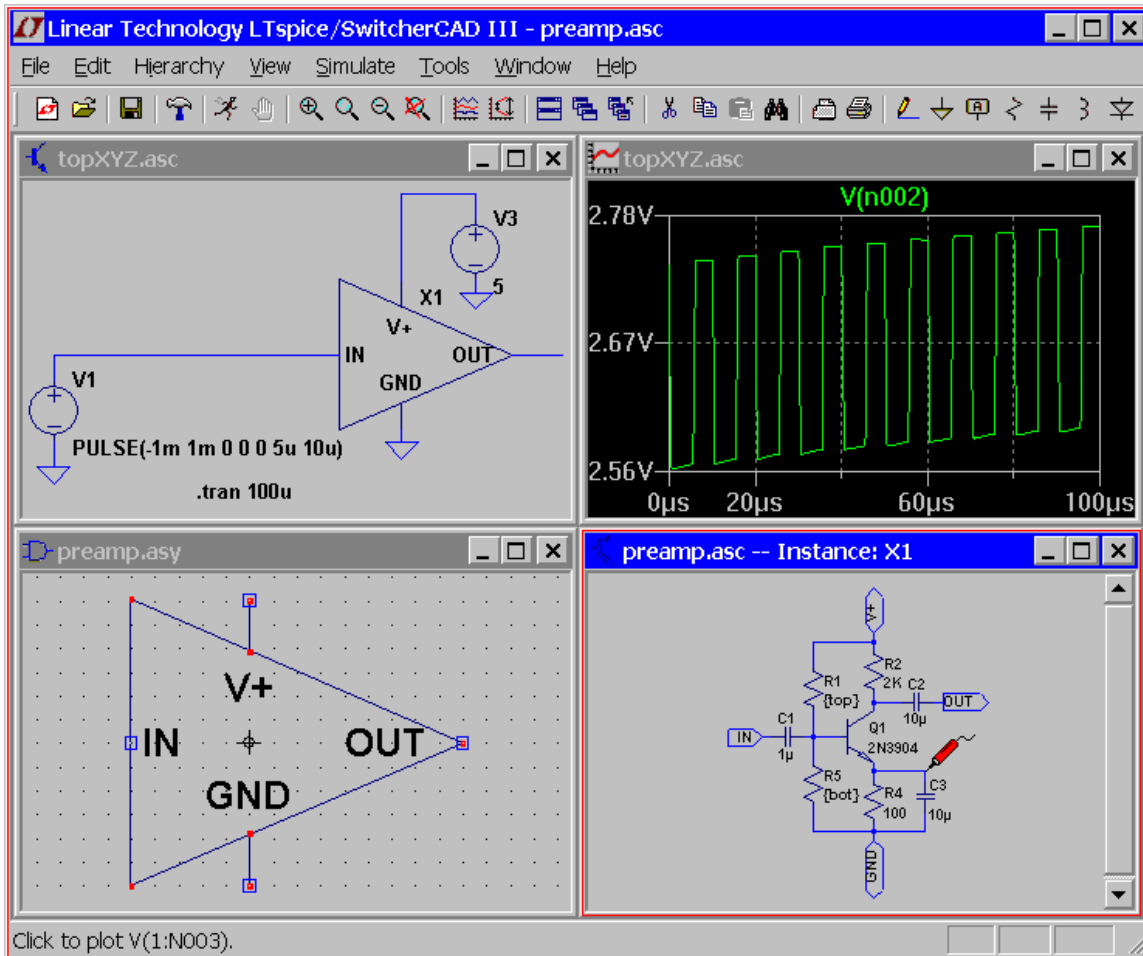

You can measure differences in this manner without performing the zoom by either pressing the Esc key or right mouse button before releasing the left mouse button.

Save Plot Configurations

The menu commands Plot Settings=>Save Plot Settings/Open Plot Settings files allow you to read and write plot configurations to disk. Plot setting files are ASCII files that have a file extension of .plt. The default filename is computed from the name of the data file by replacing the data file's ".raw" extension with ".plt". If such a file name exists when a data file is first opened, that plot settings file is read for initial plot configuration.

Each analysis type; `.tran`, `.ac`, `.noise`, etc.; has its own entry in the plot settings file. It isn't possible to load the settings from one analysis type to another. But you can use the plot settings file from another simulation of the same analysis type.

LTspice

LTspice Overview

LTspice is the circuit simulation engine for the `SwitcherCAD III`. LTspice is a schematic-driven circuit simulation program. The LTspice simulator was originally based years ago on Berkeley SPICE 3F4/5 with BSIM3v3.2.4 and other new MOSFET devices. The simulator has gone through a complete re-write in order to improve the performance of the simulator, fix bugs, and extend the simulator so that it can run industry standard semiconductor and behavioral models. A digital simulation capability has been added along with extensive enhancements to the analog SPICE simulator to make LTspice the industry superlative board-level analog and mixed-mode simulator for many classes of circuits such as switching regulators and switched-capacitor filters.

Many Linear Technology products are modeled with proprietary building blocks that accurately encapsulate realistic behavior with `custom macromodels`. This allows the power system board to be simulated and prototyped rapidly.

LTspice can be used as a general-purpose SPICE simulator. New circuits can be drafted with the built-in `schematic capture`. Simulation commands and parameters are placed as text on the schematic using established `SPICE syntax`. Waveforms of circuit nodes and device currents can be plotted by clicking the mouse on the nodes in the schematic during or after simulation.

Introduction

Circuit Description

Circuits are defined by a text netlist. The netlist consists of a list of circuit elements and their nodes, model definitions, and other SPICE commands.

The netlist is usually graphically entered. To start a new schematic, select the File=>Open menu item. A windows file browser will appear. Either select an existing schematic and save it under a new name or type in a new name to create a new blank schematic file. LTspice uses many different types of files and documents. You will want to make a file with a file name extension of ".asc". The schematic capture commands are under the Edit menu. Keyboard shortcuts for the commands are listed under Schematic Editor Overview.

When you simulate a schematic, the netlist information is extracted from the schematic graphical information to a file with the same name as the schematic but with a file extension of ".net". LTspice reads in this netlist.

You can also open, simulate, and edit a text netlist generated either by hand or externally generated. Files with the extensions ".net", ".cir", or ".sp" are recognized by LTspice as netlists.

This section of the help documents the syntax used in netlists, but occasionally gives schematic-level advice.

General Structure and Conventions

The circuit to be analyzed is described by a text file called a netlist. The first line in the netlist is ignored, that is, it is assumed to be a comment. The last line of the netlist is usually simply the line ".END", but

this can be omitted. Any lines after the line ".END" are ignored.

The order of the lines between the comment and end is irrelevant. Lines can be comments, circuit element declarations or simulation directives. Let's start with an example:

```
* This first line is ignored
* The circuit below represents an RC circuit driven
* with a 1MHz square wave signal
R1 n1 n2 1K ; a 1KOhm resistor between nodes n1 and n2
C1 n2 0 100p ; a 100pF capacitor between nodes n2 and
ground
V1 n1 0 PULSE(0 1 0 0 0 .5μ 1μ) ; a 1Mhz square wave
.tran 3μ ; do a 3μs long transient analysis
.end
```

The first two lines are comments. Any line starting with a "*" is a comment and is ignored. The line starting with "R1" declares that there is a 1K resistor connected between nodes n1 and n2. Note that the semicolon, ";", can be used to start a comment in the middle of a line. The line starting with "C1" declares that there is a 100pF capacitor between nodes n2 and ground. The node "0" is the global circuit common ground.

Below is an overview of the lexicon of LTspice:

- o Letter case, leading spaces, blanks, and tabs are ignored.
- o The first non-blank character of a line defines the type of circuit element.

character	type of line
-----------	--------------

* A comment

A - Z: A circuit element, for example, "R" for resistor, "C" for capacitor, "L" for inductor, and so on. Each element in the circuit is specified by name, as are the circuit nodes to which the elements are connected and the values of the parameters that determine the electrical characteristics of the element. The first letter of the element name specifies the element type. Hence, R, R1, RSE, ROUT, and R3AC2ZY are valid resistor names. Element names must be unique; for example, there can only be one R1 in a circuit. Some circuit elements require models to be defined to fully specify the elements electrical behavior.

. A simulation directive, For example: `.options
reltol=1e-4`

+ A continuation of the previous line. The "+" is removed and the remainder of the line is considered part of the prior line.

Numbers can be expressed not only in scientific notation; e.g., 1e12; but also using engineering multipliers. That is, 1000.0 or 1e3 can also be written as 1K. Below is a table of understood multipliers:

Suffix	multiplier

T	1e12
G	1e9
Meg	1e6
K	1e3
Mil	25.4e-6
M	1e-3
u (or μ)	1e-6
n	1e-9
p	1e-12
f	1e-15

Unrecognized letters immediately following a number or engineering multiplier are ignored. Hence, 10, 10V, 10Volts, and 10Hz all represent the same number, and M, MA, MSec, and MMhos all represent the same scale factor(1e-3). A common error is to draft a resistor with value of 1M, thinking of a one MegaOhm resistor, however, 1M is interpreted as a one milliOhm resistor. This is unfortunate, but is necessary for compatibility with standard SPICE practice.

Nodes names may be arbitrary character strings. Global circuit common node(ground) is "0", though "GND" is special synonym. Note that since nodes are character strings, "0" and "00" are distinct nodes.

Throughout the following sections of the manual, angle brackets are placed around data fields that need to be filled with specific information; for example, "<srcname>" would be the name of some specific source. Square brackets indicate that the enclosed data field is optional.

Circuit Element Quick Reference

Component	Syntax
special functions	Axx n1 n2 n3 n4 n5 n6 n7 n8 + <model> [extra parameters]
arbitrary behavioral source	Bxx n+ n- <V=... or I=...>
capacitor	Cxx n+ n- <capacitance> + [ic=<val.>] [Rser=<val.>] + [Lser=<val.>] [Rpar=<val.>] + [Cpar=<val.>] [m=<val.>]
diode	Dxx A K <model> [area]
voltage dependent voltage	Exx n+ n- nc+ nc- <gain>
current dependent current	Fxx n+ n- <Vnam> <gain>
voltage dependent current	Gxx n+ n- nc+ nc- <transcond.>
current dependent voltage	Hxx n+ n- <Vnam> <transres.>
independent current source	Ixx n+ n- <current>
JFET transistor	Jxx D G S <model> [area] [off] +[IC=<Vds,Vgs>] [temp=<T>]
mutual inductance	Kxx L1 L2 <coeff.>
inductance	Lxx n+ n- <inductance>

	+ [ic=<val.>] [Rser=<val.>]
	+ [Rpar=<val.>]
	+ [Cpar=<val.>] [m=<val.>]
MOSFET transistor	Mxx D G S B <model> [L=<len>]
	+ [W=<width>] [AD=<area>]
	+ [AS=<area>] [PD=<perim>]
	+ [PS=<perim>] [NRD=<value>]
	+ [NRS=<value>] [off]
	+ [IC=<Vds, Vgs, Vbs>
	+ [temp=<T>]
lossy transmission line	Oxx L+ L- R+ R- <model>
bipolar transistor	Qxx C B E [S] <model> [area]
	+ [off] [IC=Vbe,Vce][temp=<T>]
resistance	Rxx n1 n2 <value>
voltage controlled switch	Sxx n1 n2 nc+ nc- <model>
	+ [on,off]
lossless transmission line	Txx L+ L- R+ R- ZO=<value>
	+ TD=<value>
uniform RC-line	Uxx n1 n2 ncommon <model>
	+ L=<len> [N=<lumps>]
independent voltage source	Vxx n+ n- <voltage>
current controlled switch	Wxx n1 n2 <Vnam> <model>
	+ [on,off]
subcircuit	Xxx n1 n2 n3... <subckt name>
MESFET transistor	Zxx D G S model [area] [off]
	+ [IC=<Vds,Vgs>]

Dot Commands

C. Simulator directives -- dot commands

To run a simulation, not only must the circuit be defined, but also the type of analysis to be performed. There are six different types of analyses: linearized **small-signal AC**, **DC sweep**, noise, **DC operating point**, small-signal DC transfer function and **transient analysis**. Precisely one of these six analyses must be specified.

Whereas the circuit topology is typically schematically drafted, the commands are usually placed on the schematic as text. All such commands start with a period and are therefor called "dot commands".

.AC -- Perform an small signal AC analysis

The small-signal(linear) AC portion of LTspice computes the AC complex node voltages as a function of frequency. First, the DC operating point of the circuit is found. Next, linearized small-signal models for all of the nonlinear devices in the circuit are found for this operating point. Finally, using independent voltage and current sources as the driving signal, the resultant linearized circuit is solved in the frequency domain over the specified range of frequencies.

This mode of analysis is useful for filters, networks, stability analyses, and noise considerations.

Syntax: `.ac <oct, dec, lin> <Nsteps> <StartFreq> <EndFreq>`

The frequency is swept between frequencies StartFreq and EndFreq. The number of steps is defined with the keyword "oct", "dec", or "lin" and Nsteps according to the following table:

keyword	Nsteps
oct	No. of steps per octave
dec	No. of steps per decade
lin	Total number of linearly spaced steps between StartFreq and EndFreq

.BACKANNO -- Annotate the subcircuit pin names to the port currents

Syntax: `.backanno`

This directive is automatically included in every netlist SwitcherCAD III generates from a schematic. It directs LTspice to include information in the .raw file that can be

used to refer to port currents by the pin name. This allows you to plot the current into the pin of a symbol by mouse clicking on the symbol's pin.

.DC -- Perform a DC source sweep analysis

This performs a DC analysis while sweeping the DC value of a source. It is useful for computing the DC transfer function of an amplifier or plotting the characteristic curves of a transistor for model verification.

Syntax: `.dc <srcnam> <Vstart> <Vstop> <Vincr>
+ [<srcnam2> <Vstart2> <Vstop2> <Vincr2>]`

The `<srcnam>` is either an independent voltage or current source that is to be swept from `<Vstart>` to `<Vstop>` in `<Vincr>` step sizes. In the following example, the default BSIM3v3.2.4 characteristic curves are plotted:

```
* Example .dc sweep
*
M1 2 1 0 0 nbsim
Vgs 1 0 3.5
Vds 2 0 3.5
.dc Vds 3.5 0 -0.05 Vgs 0 3.5 0.5
.model nbsim NMOS Level=8
.save I(Vds)
.end
```

.END – End of netlist

This directive marks the end of the textual netlist. All lines after this one are ignored. Do not place this as text on the schematic, as the netlist extractor supplies it at the end.

.ENDS – End of Netlist

This directive marks the end of a subcircuit definition. See `.SUBCKT` for more information.

.FOUR -- Compute a Fourier component after a transient analysis

Syntax: `.four <frequency> [Number of Harmonics] <data trace1> [<data trace2> ...]`

Example: `.four 1kHz V(out)`

This command is performed after a transient analysis. It's supplied in order to be compatible with legacy SPICE simulators. The output from this command is printed in the `.log` file. Use the menu item "View=>Spice Error Log" to see the output. For most purposes, the FFT capability built into the waveform viewer is more useful.

.FUNC - User defined functions

Syntax: `.func <name>([args]) {<expression>}`

Example: `.func Pythag(x,y) {sqrt(x*x+y*y)}`

The `.func` directive allows the creation of user-defined functions for use with user parameterized circuits and behavioral sources. This is useful for associating a name with a function for the sake of clarity and parameterizing subcircuits so that abstract circuits can be saved in libraries.

The `.func` statement can be included inside a subcircuit definition to limit the scope the function to that subcircuit and the subcircuits invoked by that subcircuit.

To invoke parameter substitution and expression evaluation with these user-defined functions, enclose the expression in curly braces. The enclosed expression will be replaced with the floating-point value.

Below is a example using both a `.func` and `.param` statements.

```
* Example deck using a .func statement
.func myfunc(x,y) {sqrt(x*x+y*y)}
.param u=100 v=600
V1 a 0 pulse(0 1 0 1n 1n .5μ 1μ)
R1 a b {myfunc(u,v/3)}
C1 b 0 100p
.tran 3μ
.end
```

All parameter substitution evaluation is done before the simulation begins.

.GLOBAL -- Declare global nodes

Syntax: `.global <node1> [node2 [node3] [...]]`

Example: `.global VDD VCC`

The `.global` command allows you to declare that certain nodes mentioned in subcircuits are not local to subcircuit but are absolute global nodes.

Note that global circuit common is node "0" and that a `.global` statement is not required. Also, node names

that of the form "\$G_" are also global nodes without being mentioned in a .global statement.

.IC -- Set initial conditions

The .ic directive allows initial conditions for transient analysis to be specified. Node voltages and inductor currents may be specified. A DC solution is performed using the initial conditions as constraints. Note that although inductors are normally treated as short circuits in the DC solution in other SPICE programs, if an initial current is specified, they are treated as infinite-impedance current sources in LTspice.

Syntax: `.ic [V(<n1>)=<voltage>] [I(<inductor>)=<current>]`

Example: `.ic V(in)=2 V(out)=5 V(vc)=1.8 I(L1)=300m`

.INCLUDE -- Include another file

Syntax: `.include <filename>`

This directive includes the named file as if that file had been typed into the netlist instead of the .include command. This is useful for including libraries of models or subcircuits.

An absolute path name may be entered for the filename. Otherwise LTspice looks first in the directory <SwCADIII>\lib\sub and then in the directory that contains the calling netlist, where <SwCADIII> is the directory containing the scad3.exe executable, typically installed as C:\Program Files\LTC\SwCADIII.

No file name extension is assumed. You must use ".inc myfile.lib" not ".inc myfile" if the file is called "myfile.lib"

.LIB -- Include a library

Syntax: .lib <filename>

This directive includes the model and subcircuit definitions of the named file as if that file had been typed into the netlist instead of the .lib command. Circuit elements at global scope are ignored.

An absolute path name may be entered for the filename. Otherwise LTspice looks first in the directory <SwCADIII>\lib\cmp and then <SwCADIII>\lib\sub and then in the directory that contains the calling netlist, where <SwCADIII> is the directory containing the scad3.exe executable, typically installed as C:\Program Files\LTC\SwCADIII.

No file name extension is assumed. You must use ".lib myfile.lib" not ".lib myfile" if the file is called "myfile.lib"

.MODEL – Define a SPICE model

Defines a model for a diode, transistor, switch, lossy transmission line or uniform RC line

Some circuit elements, for example, transistors, have many parameters. Instead of defining every transistor parameter for every instance of a transistor, transistors are grouped by model name and have parameters in common. The transistors of the same model can have different sizes and

the electrical behavior is scaled to the size of the instance.

Syntax: `.model <modname> <type>[(<parameter list>)]`

The model name must be unique. That is, two different types of circuit elements, such as a diode and a transistor, cannot have the same model name. The parameter list depends on the type of model. Below is a list of model types:

Type	associated circuit element
SW	Voltage controlled switch
CSW	Current controlled switch
URC	Uniform distributed RC model
LTRA	Lossy transmission line model
D	Diode model
NPN	NPN BJT model
PNP	PNP BJT model
NJF	N-channel JFET model
PJF	P-channel JFET model
NMOS	N-channel MOSFET model
PMOS	P-channel MOSFET model
NMF	N-channel MESFET model
PMF	P-channel MESFET model
VDMOS	Vertical doubly diffused power MOSFET model

See the description of the circuit element for a list of which parameters are instance specific and which are common to a model.

.NODESET -- Supply hints for initial DC solution

The `.nodeset` directive supplies hints for finding the DC operating point. If a circuit has multiple possible DC states as, for example, a flipflop, the iteration process for finding the DC solution may never converge. A `.nodeset` directive can be used to lead the circuit to one or another state. Basically,

after a solution pass is done with the voltage specified on the nodeset directive, the constraint is removed for subsequent iterative passes.

Syntax: `.NODESET V(node1)=<voltage> [V(node2)=<voltage> [...]]`

.NOISE -- Perform a noise analysis

This is a frequency domain analysis that computes the noise due to Johnson noise and flicker (1/f) noise.

Syntax: `.noise V(<out>[,<ref>]) <src> <oct, dec, lin> + <Nsteps> <StartFreq> <EndFreq>`

`V(<out>[,<ref>])` is the node at which the total output noise is calculated. It can be expressed as `V(n1, n2)` to represent the voltage between two nodes. `<src>` is the name of an independent source to which input noise is referred. The parameters `<oct, dec, lin>`, `<Nsteps>`, `<StartFreq>`, and `<EndFreq>` define the frequency range and resolution of interest in the manner used in the `.ac` directive.

.OP -- Find the DC operating point

Perform a DC solution with capacitances open circuited and inductances short circuited. Usually a DC solution is performed as part of another analysis in order to find the operating point of the circuit. Use `.op` if you wish only this operating point to be found. The results will appear in a dialog box. After a `.OP` simulation, when you point at a node or current the `.OP` solution will appear on the status bar.

.OPTIONS -- Set simulator options

Keyword	data type	default value	Description
abstol	num.	1pA	Absolute current error tolerance
baudrate	num.	(none)	Used for eye diagrams. Tells the waveform graphic package how to wrap the time ordinate to overlay the bit transitions
chgtol	num.	10fC	Absolute charge tolerance
defad	num.	0.	Default MOS drain diffusion area
defas	num.	0.	Default MOS source diffusion area
defl	num.	100μm	Default MOS channel length
defw	num.	100μm	Default MOS channel width
delay	num.	(none)	Used for eye diagrams. Shifts the bit transitions in the diagram.
flagloads	flag	false	flag external current sources as loads
frain	num.	(none)	Input node for freq. response analysis
fraout	num.	(none)	Output node for freq. response analysis
frastop	num.	(none)	high freq. for freq. response analysis
frastart	num.	(none)	lowest frequency for frequency response analysis
fraamp	num.	(none)	fra func ampl. for freq. response analysis

fravref	num.	(none)	additional DC offset of Vin Freq. response analysis
Gmin	num.	1e-12	Conductance added to every PN junction to aid convergence
gminsteps	num.	25	number of steps to every PN junction to achieve
convergence			
itl1	num.	100.	DC iteration count limit
itl2	num.	50.	DC transfer curve iteration count limit
itl4	num.	10.	Transient analysis time point iteration count limit
itl6	num.	25.	number of steps to use in source stepping(used for difficult DC operating point solutions)
srcsteps	num.	25.	alternative name for itl6
maxclocks	num.	infin.	max number of clock cycles to save
maxstep transient	num.	infin.	Maximum step size for analysis
method	string	trap	Numerical integration method, either trapezoidal or Gear
minclocks	num.	10	min. number of clock cycles to save
nomarch	flag	false	Do not plot marching waveforms
noopiter	flag	false	Go directly to gmin stepping.
oversample	num.	(none)	For Freq. response analysis
pivrel	num.	1e-3	Relative ratio between the

			largest column entry and an acceptable pivot value.
pivtol	num.	1e-13	Absolute minimum value for a matrix entry to be accepted as a pivot.
reltol	num.	0.001	Relative error tolerance
startclocks	num.	5	number of clock cycles to wait before looking for steadystate
sstol	num.	0.001	rel. error for steady-state detection
temp circuit	num.	27°C	Default temperature for element instances that don't specify temperature
tnom	num.	27°C	Default temperature at which device parameters were measured for models that don't specify this temperature
trtol	num.	1.0	Set the transient error tolerance. This parameter is an estimate of the factor by which the actual truncation error is overestimated.
trytocompact	flag	not set	When flagged, the simulator tries to condense LTRA transmission lines' history of input voltages and currents.
tstepload	num.	1µs	Transition time for step load response
vntol	num.	1µV	Sets the absolute voltage error tolerance.

.PARAM -- User-defined parameters

The .param directive allows the creation of user-defined variables. This is useful for associating a name with a value for the sake of clarity and parameterizing subcircuits so that abstract circuits can be saved in libraries.

The .param statement can be included inside a subcircuit definition to limit the scope the parameter value to that subcircuit and subcircuits invoked by that subcircuit.

To invoke parameter substitution and expression evaluation, enclose the expression in curly braces. The enclosed expression will be replaced with the floating-point value.

Below is a example using both a .param statement and directly passing parameters on the subcircuit invocation line.

```
*
* This is the circuit definition
.param x=y y=z z=1k*tan(pi/4+.1)
X1 a b 0 divider top=x bot=z
V1 a 0 pulse(0 1 0 .5μ .5μ 0 1μ)

* this is the definition of the subcircuit
.subckt divider n1 n2 n3
r1 n1 n2 {top}
r2 n2 n3 {bot}
.ends
*

.tran 3μ
.end
```

The parameter substitution scheme is a symbolic declarative language. The parameters are not passed to the subcircuit as evaluated values, but by the expressions and relations themselves. When curly braces are encountered, the enclosed expression is evaluated on the basis of all relations available at the scope and reduced to a floating point value.

.SAVE -- Limit the amount of saved data.

Some simulations, particularly time domain simulations, can generate large amount of data. The amount of output can be restricted by using the .save directive to save only the specific node voltages and device current of interest.

Syntax: `.save V(out) [V(in) [I(L1) [I(S2)]]] [dialogbox]`

The directive `.save I(Q2)` will save the base, collector and emitter currents of bipolar transistor Q2. It is not possible to save only one terminal.

If the keyword `dialogbox` is specified, then a dialog box with a list of all-available default nodes and currents is displayed; allowing the user to select from the list which should be saved. If the netlist was generated from a schematic, then nodes and devices can be pointed to and clicked on in the schematic to highlight them as selected in the dialog box.

.STEP -- Parameter sweeps

This command causes an analysis to be repeatedly performed while stepping the temperature, a model parameter, a global parameter, or an independent source. Steps may be linear, logarithmic, or specified as a list of values.

Example: `.step oct v1 1 20 5`

Step independent voltage source V1 from 1 to 20 logarithmically with 5 points per octave.

Example: `.step I1 10u 100u 10u`

Step independent current source I1 from 10u to 100u in step increments of 10u.

Example: `.step param RLOAD LIST 5 10 15`

Perform the simulation three times with global parameter Rload being 5, 10 and 15.

Example: `.step NPN 2N2222(VAF) 50 100 25`

Step NPN model parameter VAF from 50 to 100 in steps of 25.

Example: `.step temp -55 125 10`

Step the temperature from -55°C to 125°C in 10-degree step. Step sweeps may be nested up to three levels deep.

.SUBCKT -- Define a subcircuit

As an aid to defining a circuit, repetitive circuitry can be enclosed in a subcircuit definition and used as multiple instances in the same circuit. Before the simulation runs, the circuit is expanded to a flat netlist by replacing each invocation of a subcircuit with the circuit elements in the subcircuit definition. There is no limit on the size or complexity of subcircuits.

The end of a subcircuit definition must be a `.ends` directive.

Here is an example using a subcircuit:

```

*
* This is the circuit definition
X1 a b 0 divider
V1 a 0 pulse(0 1 0 .5μ .5μ 0 1μ)

* this is the definition of the subcircuit
.subckt divider n1 n2 n3
r1 n1 n2 1k
r2 n2 n3 1k
.ends

.tran 3μ
.end

```

Which runs after expanding to

```

* Expand X1 into two resistor network
r:1:1 a b 1k
r:1:2 b 0 1k
*
v1 a 0 pulse(0 1 0 .5μ .5μ 0 1μ)
.tran 3μ
.end

```

Note that unique names based on the subcircuit name and the subcircuit definition element names are made for the circuit elements inserted by subcircuit expansion.

.TEMP -- Temperature sweeps

This is an archaic form for the step command for temperature. It performs the simulation for each temperature listed.

The syntax

```
.TEMP <T1> <T2> ...
```

is equivalent to

```
.STEP TEMP LIST <T1> <T2> ...
```

.TF -- Find the DC small-signal transfer function

This is an analysis mode that finds the DC small-signal transfer function of a node voltage or branch current due to small variations of an independent source.

Syntax: `.TF V(<node>[, <ref>]) <source>`
`.TF I(<voltage source>) <source>`

Examples:

```
.TF V(out) Vin  
.TF V(5,3) Vin  
.TF I(Vload) Vin
```

.TRAN -- Perform a nonlinear transient analysis

Perform a transient analysis. This is the most direct simulation of a circuit. It basically computes what happens when the circuit is powered up. Test signals are often applied as independent sources.

Syntax: `.TRAN <Tstep> <Tstop> [Tstart [dTmax]] [modifiers]`
`.TRAN <Tstop> [modifiers]`

The first form is the traditional `.tran` SPICE command. `Tstep` is the plotting increment for the waveforms but is

also used as an initial step-size guess. LTspice uses waveform compression, so this parameter is of little value and can be omitted or set to zero. Tstop is the duration of the simulation. Transient analyses always start at time equal to zero. However, if Tstart is specified, the waveform data between zero and Tstart is not saved. This is a means of managing the size of waveform files by allowing startup transients to be ignored. The final parameter dTmax, is the maximum time step to take while integrating the circuit equations. If Tstart or dTmax is specified, Tstep must be specified.

Several **modifiers** can be placed on the .tran line.

.WAVE -- Write selected nodes to a .wav file.

LTspice can write .wav audio files. These files can then be listened to or be used as the input of another simulation.

Syntax: .wave <filename.wav> <Nbits> <SampleRate>
V(out) [V(out2) ...]

example: .wave C:\output.wav 16 44.1K V(left) V(right)

<filename.wav> is either a complete absolute path for the .wav file you wish to create or a relative path computed from the directory containing the simulation schematic or netlist. Double quotes may be used to specify a path containing spaces. <Nbits> is the number of sampling bits. The valid range is from 1 to 32 bits. <SampleRate> is the number of samples to write per simulated second. The valid range is 1 to 4294967295 samples per second. The remainder of the syntax lists the nodes that you wish to save. Each node will be an independent channel in the .wav file. The number of channels may be as few as one or as many as 65536. It is possible to write a device current, e.g., Ib(Q1) as well as node voltage. The .wav analog to digital converter has a full scale range of -1 to +1 Volt or Amp.

Note that it is possible to write .wav files that cannot be played on your PC sound system because of the number of

channels, sample rate or number of bits due to limitations of your PC's codec. But these .wav files may still be used in LTspice as input for another simulation. See the section LTspice=>Circuit Elements=>V. Voltage Source and I. Current source for information on playing a .wav file into a LTspice simulation.

Transient Analysis Options

.TRAN Modifiers

UIC: Skip the D.C. operating solution and use user-specified initial conditions.

steady: Stop the simulation when steady state has been reached.

nodiscard: Don't delete the part of the transient simulation before steady state is reached.

startup: Solve the initial operating point with independent voltage and current sources turned off. Then start the transient analysis and turn these sources on in the first 5 us of the simulation.

step: Compute the step response of the circuit.

UIC

Use Initial Conditions. Normally, a DC operating point analysis is performed before starting the transient analysis. This directive suppresses this initialization. The initial conditions of some circuit elements can be specified on an instance-per-instance basis. Uic is not a particularly recommended feature of SPICE. Skipping the DC operating point analysis leads to a nonphysical initial condition. For example, consider a voltage source connected in parallel to a capacitance. The node voltage is taken as zero if not specified. Then, in the first time step, an infinite current is required to charge the capacitor. The simulator

cannot find a short enough time step to make the current nonsingular, and a "time step too small convergence fail" message is issued.

startup

This is similar to SPICE's original "uic". It means that independent sources should be ramped on during the first 20 μ s of the simulation. However, a DC operating point analysis is performed using the constraints specified on a .ic directive.

steady

Stop the simulation when steady state has been reached. The clues for steady state detection are specified in .option statements through the keywords burst, continuous, burstnode, clknode, vcnode, innode, outnode, startclocks, minclocks, maxclocks and sstol. Use the .ic directive to specify node voltages and inductor currents to reduce the length of the transient analysis required to find the steady state.

nodiscard

Don't delete the part of the transient simulation before steady state is reached.

step

Compute the step response of the circuit. This function works with a current source used as a load with a list of step currents. The procedure is:

- 1) compute to steady state and discard the history unless `nodiscard` is set.
- 2) ramp the step load to the next value in the list of currents to step over a period specified by the option `tstepload`.
- 3) compute to steady state
- 4) change the step load to the next value in the list or quit if there is none.

Due to the circuit complexity, the automatic STEP transition might not be detectable. Under this circumstance, it is best to use the `.TRAN` command to run the transient simulation and observe the starting and ending periods of the desired step load response. Use `PWL` command to program the output load current and switches to different levels at desired time periods. For example:

```
pwl(0 0.5 1m 0.5 1.01m 0.1 3m 0.1 3.01m 0.5)
```

The load current starts with 0.5A at time 0,

stays at 0.5A at 1ms,

switches to 0.1A at time 1.01ms,

stays at 0.1A until 3ms,

and switches to 0.5A at 3.01ms and stays at 0.5A.

The `PWL` can have almost unlimited pairs of (time, value) sequence.

Circuit Elements

A. Special functions.

Symbol names: `INV`, `BUF`, `AND`, `OR`, `XOR`, `SCHMITT`, `SCHMTBUF`, `SCHMTINV`, `DFLOP`, `VARISTOR`, and `MODULATE`

Syntax: Annn n001 n002 n003 n001 n004 n005 n006 n007 n008
<model> [instance parameters]

These are Linear Technology Corporation's proprietary special function/mixed mode simulation devices. Most of these and their behavior are undocumented as they frequently change with each new set of models available for LTspice. However, here we document some of them because of their general interest.

INV, BUF, AND, OR, and XOR are generic idealized behavioral gates. All gates are netlisted with eight terminals. These gates require no external power. Current is sourced or sunk from the complimentary outputs, terminals 6 and 7, and returned through device common, terminal 8. Terminals 1 through 5 are inputs. Unused inputs and outputs are to be connected to terminal 8. The digital device compiler recognizes that as a flag that that terminal is not used and removes it from the simulation. This leads to the potentially confusing situation where AND gates act differently when an input is grounded or at zero volts. If ground is the gate's common, then the grounded input is not at a logic false condition, but simply not part of the simulation. The reason that these gates are implemented like that is that this allows one device to act as 2-, 3-, 4- or 5- input gates with true, inverted, or complimentary output with no simulation speed penalty for unused terminals. That is, the AND device acts as 12 different types of AND gates. The gates default to 0V/1V logic with a logic threshold of .5V, no propagation delay, and a 10hm output impedance. Output characteristics are set with these instance parameters:

parameter	default	meaning
Vhigh	1V	logic high level
Vlow	0V	logic low level
Ihigh	1A	logic high drive current
Ilow	0A	logic low drive current
Trise	0	Rise time
Tfall	Trise	Fall time
Tau	0	output RC time constant
Cout	0	output capacitance

Rout		1		output impedance
Rhigh		Rout		logic high level impedance
Rlow		Rout		logic low level impedance

Note that not all parameters can be specified on the same instance at the same time, e.g., the output characteristics are either a slewing rise time or an RC time constant, not both.

The propagation delay defaults to zero and is set with instance parameter Td. Input hold time is equal to the propagation delay.

The input logic threshold defaults to $.5*(V_{high}+V_{low})$ but can be set with the instance parameter Ref. The hold time is equal to the propagation delay.

The Schmidt trigger devices have similar output characteristics as the gates. Their trip points are specified with instance parameters Vt and Vh. The low trip point is V_t-V_h and the high trip point is V_t+V_h .

The gates and Schmidt trigger devices supply no timestep information to the simulation engine by default. That is, they don't look when they are about to change state and make sure there's a timestep close to either side of the state change. The instance parameter tripdt can be set to stipulate a maximum timestep size the simulator takes across state changes.

The VARISTOR is a voltage controlled varistor. Its breakdown voltage is set by the voltage between terminals 1 and 2. Its breakdown impedance is specified with the instance parameter rclamp. See the example schematic `.\examples\Educational\varistor.asc`

The MODULATE device is a voltage controlled oscillator. See the example schematic `.\examples\Educational\PLL.asc`. The instantaneous oscillation frequency is set by the voltage on the FM input. The conversion from voltage to frequency is linear and set by the two instance parameters, mark and space. Mark is the frequency when the FM input is at 1V and space is the frequency when the input is at 0V. The amplitude is set by the voltage on the AM input and defaults to 1V if that input is unused (connected to the MODULATE common).

The schematic capture aspect of LTspice netlists symbols for these devices in a special manner. All unconnected terminals are automatically connected to terminal 8. Also, if terminal 8 is unconnected, then it is connected to node 0.

B. Arbitrary behavioral voltage or current sources.

Symbol names: BV, BI

```
Syntax:  Bnnn n001 n002 V=<expression> [ic=<value>]
         + [tripdv=<value>] [tripdt=<value>]
         + [laplace=<expression> [window=<time>]]
         + [nfft=<number>] [mtol=<number>]]

         Bnnn n001 n002 I=<expression> [ic=<value>]
         + [tripdv=<value>] [tripdt=<value>] [Rpar=<value>]
         + [laplace=<expression> [window=<time>]]
         + [nfft=<number>] [mtol=<number>] ]
```

The first syntax specifies a behavioral voltage source and the next is a behavioral current source. For the current source, a parallel resistance may be specified with the Rpar instance parameter.

Tripdv and tripdt control step rejection. If the voltage across a source changes by more than tripdv volts in tripdt seconds, that simulation time step is rejected.

Expressions can contain the following:

- o Node voltages, e.g., V(n001)
- o Node voltage differences, e.g., V(n001, n002)
- o Circuit element currents; for example, I(S1), the current through switch S1 or Ib(Q1), the base current of Q1. However, it is assumed that the circuit element current is varying quasi-statically, that is, there is no instantaneous feedback between the current through the referenced device and the behavioral source output.
- o The keyword, "time" meaning the current time in the simulation.
- o The keyword, "pi" meaning 3.14159265358979323846.
- o The following functions:

name	function
abs(x)	absolute value
acos(x)	arc cosine of x
acosh(x)	arc hyperbolic cosine
asin(x)	arc sine
asinh(x)	arc hyperbolic sine
atan(x)	arc tangent
atan2(y, x)	four quadrant arc tangent of y/x
atanh(x)	arc hyperbolic tangent
cos(x)	cosine
cosh(x)	hyperbolic
exp(x)	exponential
ln(x)	natural logarithm
log(x)	natural logarithm
log10(x)	base 10 logarithm

sgn(x)		sign
sin(x)		sine
sinh(x)		hyperbolic sine
sqrt(x)		square root
tan(x)		tangent
tanh(x)		hyperbolic tangent
u(x)		unit step, 1 if x > 0., else 0.
buf(x)		1 if x > .5, else 0
inv(x)		0 if x > .5, else 1
uramp(x)		x if x > 0., else 0.
!(x)		alternative syntax for inv(x)
int(x)		convert x to integer
floor(x)		integer equal or less than x
ceil(x)		integer equal or greater than x
rand(x)		random number between 0 and 1.
min(x,y)		the less of x or y
max(x,y)		the greater of x or y
limit(x,y,z)		equivalent to min(max(x,y),z)
if(x,y,z)		if x > .5, then y else z
table(x,a,b,c,d,...)		interpolate a value for x based on a look up table given as a set of pairs of points

- o The following operations, grouped in reverse order of precedence of evaluation:

	Description
&	convert the expressions to either side to Boolean, then AND
	convert the expressions to either side to Boolean, then OR
^	convert the expressions to either side to Boolean, then XOR
<	true if expression on the left is less than the expression on the right, otherwise false
>	true if expression on the left is greater than the expression on the right, otherwise false
<=	true if expression on the left is less than or equal the expression on the right, otherwise false
>=	true if expression on the left is greater than or equal the expression on the right,

```

    | otherwise false
    |
+ | floating point addition
- | floating point subtraction
    |
* | floating point multiplication
/ | floating point division
    |
**| raise left hand side to power of right hand
   | side
! | convert the following expression to Boolean
   | and invert

```

True is numerically equal to 1 and False is 0. Conversion to Boolean converts a value to 1 if the value is greater than 0.5, otherwise the value is converted to 0.

If the optional Laplace transform is defined, that transform is applied to the result of the behavioral current or voltage signal. The Laplace transform must be a function of s . The frequency response at frequency f is found by substituting s with $\sqrt{-1} \cdot 2 \cdot \pi \cdot f$. The time domain behavior is found from the impulse response found from the Fourier transform of the frequency domain response. LTspice must guess an appropriate frequency range and resolution. The response must drop at high frequencies or an error is reported. It is recommended that the LTspice first be allowed to make a guess at this and then check the accuracy by reducing `reltol` or explicitly setting `nfft` and the window. The reciprocal of the value of the window is the frequency resolution. The value of `nfft` times this resolution is the highest frequency considered. The Boolean XOR operator, "`^`" is understood to mean exponentiation "`**`" when used in a Laplace expression.

C. Capacitor

Symbol names: CAP, POLCAP

Syntax: Cnnn n1 n2 <capacitance> [ic=<value>]
 + [Rser=<value>] [Lser=<value>] [Rpar=<value>]

```

+ [Cpar=<value>] [m=<value>]
+ [RLshunt=<value>]

```

It is possible to specify an equivalent series resistance, series inductance, parallel resistance and parallel shut capacitance. The equivalent circuit is given below:

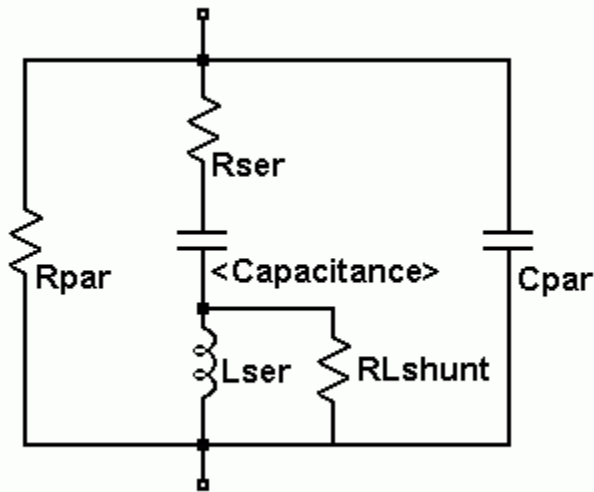

Capacitor Instance Parameters

name	parameter
Rser	equivalent series resistance
Lser	equivalent series inductance
Rpar	equivalent parallel resistance
Cpar	equivalent parallel capacitance
RLshunt	shunt resistance across Lser
m	number of parallel units
ic	initial voltage(used only if uic is flagged on the .tran card)

It is computationally better to include the parasitic Rpar, Rser, RLshunt, Cpar and Lser in the capacitor than to explicitly draft them. LTspice uses proprietary circuit

simulation technology to simulate this model of a physical capacitor without any internal nodes. This makes the simulation matrix smaller, faster to compute and less likely to be singular at short time steps.

Note that since the capacitor element includes these parasitics, it is useful for macromodeling the fundamental of a piezoelectric crystal.

There is also a general nonlinear capacitor available. Instead of specifying the capacitance, one writes an expression for the charge.

LTspice will compile this expression and symbolically differentiate it with respect to all the variables, finding the partial derivative's that correspond to capacitances.

Syntax: Cnnn n1 n2 Q=<expression> [ic=<value>] [m=<value>]

There is a special variable, *x*, that means the voltage across the device. Therefore, a 100pF constant capacitance can be written as

```
Cnnn n1 n2 Q=100p*x
```

A capacitance with an abrupt change from 100p to 300p at zero volts can be written as

```
Cnnn n1 n2 Q=x*if(x<0,100p,300p)
```

This device is useful for rapidly evaluating the behavior of a new a hypothetical charge model for, e.g., a transistor.

D. Diode

Symbol Names: DIODE, ZENER, SCHOTTKY, VARACTOR.

Syntax: Dnnn anode cathode <model> [area]
+ [off] [m=<val>]

Examples:

```
D1 SW OUT MyIdealDiode
```

```
.model MyIdealDiode D(Ron=.1 Roff=1Meg Vfwd=.4)
```

```
D2 SW OUT dio2
```

```
.model dio2 D(Is=1e-10)
```

A diode requires a `.model` card to specify its characteristics. There are two types of diodes available. One is a conduction region-wise linear model that yields a computationally light-weight representation of an idealized diode. It has three linear regions of conduction: on, off and reverse breakdown.

Below are the model parameters for this type of diode:

name	parameter	units	default
Ron	resistance in forward conduction	Ohm	1.
Roff	resistance when off	Ohm	1/gmin
Vfwd	forward threshold voltage to enter conduction	V	0.
Vrev	reverse breakdown voltage	V	
infin.			
Rrev	breakdown impedance	Ohm	Ron

This idealized model is used if any of Ron, Roff, Vfwd, Vrev or Rrev is specified in the model.

The other model available is the standard Berkeley SPICE semiconductor diode but extended to handle more detailed breakdown behavior and recombination current. The area factor determines the number of equivalent parallel devices of a specified model. Below are the diode model parameters for this diode.

name	parameter	units	default	example
Is	saturation current	A	1e-14	1e-7
Rs	ohmic resistance	Ohms	0	10
N	emission coefficient	-	1	1.
Tt	transit-time	sec	0	0.1ns
Cjo	zero-bias junction cap.	F	0	2p
Vj	junction potential	V	1	0.6
M	grading coefficient	-	0.5	0.5
Eg	activation energy	eV	1.11	1.11 Si 0.69 Sbd 0.67 Ge
XTI	sat.-current temp. exp	-	3.0	3.0 jn 2.0 Sbd
Kf	flicker noise coeff.	-	0	
Af	flicker noise exponent	-	1	
Fc	coeff. for forward-bias depletion capacitance formula	-	0.5	
BV	reverse breakdown voltage	V	infin.	40.
Ibv	current at breakdown voltage	A		1e-10
Tnom	parameter measurement temp.	°C	27	50
Isr	recombination current parameter	A	0	
Nr	Isr emission coeff.	-	2	
Ikf	high-injection knee current	A	infin.	
Tikf	linear Ikf temp coeff	/°C	0	
Trs1	linear Rs temp coeff	/°C	0	
Trs2	quadratic Rs temp coeff	/°C/°C	0	

It is possible to specify voltage, current, and power dissipation ratings for a model. These model parameters do not affect the electrical behavior. They allow LTspice to

check if the diode is being used beyond its rated capability. The following parameters apply to either model. These parameters do not scale with area.

name	parameter	units	default
Vpk	Peak voltage rating	V	(none)
Ipk	Peak current rating	A	(none)
Iave	Ave current rating	A	(none)
Irms	RMS current rating	A	(none)
diss	maximum power dissipation rating	W	(none)

E. Voltage Dependent Voltage Source

Symbol Names: E, E2

There are three types of voltage-dependent voltage-source circuit elements.

Syntax: Exxx n+ n- nc+ nc- <gain>

This circuit element asserts an output voltage between the nodes n+ and n- that depends on the input voltage between nodes nc+ and nc-. This is a linearly dependent source specified solely by a constant gain.

Syntax: Exxx n+ n- nc+ nc- table=(<value pair>, <value pair>, ...)

A look-up table is used to specify the transfer function. The table is a list of pairs of numbers. The second value of the pair is the output voltage when the control voltage is equal to the first value of that pair. The output is linearly interpolated when the control voltage is between specified points. If the control voltage is beyond the range of the look-up table, the output voltage is

extrapolated as a constant voltage of the last point of the look-up table.

Syntax: Exxx n+ n- nc+ nc- Laplace=<func(s)>
+ [window=<time>] [nfft=<number>] [mtol=<number>]

The transfer function of this circuit element is specified by its Laplace transform. The Laplace transform must be a function of s . The frequency response at frequency f is found by substituting s with $\sqrt{-1} * 2 * \pi * f$. The time domain behavior is found from the impulse response found from the Fourier transform of the frequency domain response. LTspice must guess an appropriate frequency range and resolution. The response must drop at high frequencies or an error is reported. It is recommended that the LTspice first be allowed to make a guess at this and then check the accuracy by reducing `reltol` or explicitly setting `nfft` and the window. The reciprocal of the value of the window is the frequency resolution. The value of `nfft` times this resolution is the highest frequency considered. The Boolean XOR operator, "`^`" is understood to mean exponentiation "`**`" when used in a Laplace expression.

Syntax: Exxx n+ n- value={<expression>} This is an alternative syntax of the behavioral source, arbitrary behavioral voltage source, B.

Syntax: Exxx n+ n- POLY(<N>) <(node1+,node1-)
(node2+,node2-)
+ ... (nodeN+,nodeN-)> <c0 c1 c2 c3 c4 ...>

This is an archaic means of arbitrary behavioral modeling with a polynomial. It is useful for running existing Linear Technology behavioral models.

Note: It is better to use a G source shunted with a resistance to approximate an E source than to use an E source. A voltage controlled current source shunted with a resistance will compute faster and cause fewer convergence problems than a voltage controlled voltage source. Also, the resultant nonzero output impedance is more representative of a practical circuit.

F. Current Dependent Current Source

Symbol Name: F

Syntax: Fxxx n+ n- <Vnam> <gain>

This circuit element applies a current between nodes n+ and n-. The current applied is equal to the value of the gain times the current through the voltage source specified as <Vnam>.

Syntax: Fxxx n+ n- value={<expression>}

This is an alternative syntax of the behavioral source, arbitrary behavioral voltage source, B.

Syntax: Fxxx n+ n- POLY(<N>) <V1 V2 ... VN> <c0 c1 c2 c3 c4 ...>

This is an archaic means of arbitrary behavioral modeling with a polynomial. It is useful for running existing Linear Technology behavioral models.

G. Voltage Dependent Current Source

Symbol Names: G, G2

There are three types of voltage dependent current-source circuit elements.

Syntax: Gxxx n+ n- nc+ nc- <gain>

This circuit element asserts an output current between the nodes n+ and n- that depends on the input voltage between nodes nc+ and nc-. This is a linearly dependent source specified solely by a constant gain.

Syntax: Gxxx n+ n- nc+ nc- table=(`<value pair>`, `<value pair>`, ...)

Here a lookup table is used to specify the transfer function. The table is a list of pairs of numbers. The second value of the pair is the output current when the control voltage is equal to the first value of that pair. The output is linearly interpolated when the control voltage is between specified points. If the control voltage is beyond the range of the look-up table, the output current is extrapolated as a constant current of the last point of the look-up table.

Syntax: Gxxx n+ n- nc+ nc- Laplace=`<func(s)>`
+ [window=`<time>`] [nfft=`<number>`] [mtol=`<number>`]

The transfer function of this circuit element is specified by its Laplace transform. The Laplace transform must be a function of s. The frequency response at frequency f is found by substituting s with $\sqrt{-1} \cdot 2 \cdot \pi \cdot f$. The time-domain behavior is found from the impulse response, which is found from the Fourier transform of the frequency-domain response. LTspice must guess an appropriate frequency range and resolution. The response must drop at high frequencies or an error is reported. It is recommended that the LTspice first be allowed to make a guess at this and then check the accuracy by reducing reltol or explicitly setting nfft and window. The reciprocal of the value of window is the frequency resolution. The value of nfft times this resolution is the highest frequency considered. The Boolean XOR operator, "^" is understood to mean exponentiation "***" when used in a Laplace expression.

Syntax: Gxxx n+ n- value={<expression>} This is an alternative syntax of the behavioral source, arbitrary behavioral voltage source, B.

Syntax: Gxxx n+ n- POLY(<N>) <(node1+,node1-)
(node2+,node2-)
+ ... (nodeN+,nodeN-)> <c0 c1 c2 c3 c4 ...>

This is an archaic means of arbitrary behavioral modeling with a polynomial. It is useful for running existing Linear Technology behavioral models.

H. Current Dependent Voltage Source

Symbol Name: H

Syntax: Hxxx n+ n- <Vnam> <transresistance>

This circuit element applies a voltage between nodes n+ and n-. The voltage applied is equal to the value of the gain times the current through the voltage source <Vnam>.

Syntax: Hxxx n+ n- value={<expression>}

This is an alternative syntax of the behavioral source, arbitrary behavioral voltage source, B.

Syntax: Hxxx n+ n- POLY(<N>) <V1 V2 ... V3> <c0 c1 c2
c3 c4 ...>

This is an archaic means of arbitrary behavioral modeling with a polynomial. It is useful for running existing Linear Technology behavioral models.

I. Current Source

Symbol Name: CURRENT

Syntax: Ixxx n+ n- <current> [AC=<amplitude>] [load]

This circuit element sources a constant current between nodes n+ and n-. If the source is flagged as a load, the source is forced to be dissipative, that is, the current goes to zero if the voltage between nodes n+ and n- goes to zero or a negative value. The purpose of this options is to model a current load on a power supply that doesn't draw current if the output voltage is zero.

For AC analysis, the value of AC is used as the amplitude of the source at the analysis frequency.

Syntax: Ixxx n+ n- PULSE(Ioff Ion Tdelay Trise Tfall Ton Tperiod Ncycles)

Time-dependent pulsed current source

name	parameter	units
Ioff	initial value	Amps
Ion	pulsed value	Amps
Tdelay	delay	seconds
Tr	rise time	seconds
Tf	fall time	seconds
Ton	on time	seconds
Tperiod	period	seconds
Ncycles	number of cycles wave	cycles

Syntax: Ixxx n+ n- SINE(Ioffset Iamp Freq Td Theta Phi Ncycles)

Time-dependent sine wave current source.

name	parameter	units
Ioffset	DC. offset	Amps

Iamp	amplitude	Amps
Freq	frequency	Hz
Td	delay	seconds
Theta	damping factor	1/seconds
Phi	phase of sine wave	degrees
Ncycles	number of cycles wave	cycles

For times less than Td or times after completing Ncycles, have run, the output current is given by $I_{offset} + I_{amp} \sin(\pi \cdot \phi / 180)$ Otherwise the current is given by

$$I_{offset} + I_{amp} \exp(-(\text{time} - T_d) \cdot \Theta) \sin(2 \cdot \pi \cdot \text{Freq} \cdot (\text{time} - T_d) + \pi \cdot \phi / 180)$$

The damping factor, Theta, is the reciprocal of the decay time constant.

Syntax: Ixxx n+ n- Ixxx n+ n- EXP(I1 I2 Td1 Tau1 Td2 Tau2)

Time-dependent exponential current source

name	parameter	units
I1	initial value	Amps
I2	pulsed value	Amps
Td1	rise delay time	seconds
Tau1	rise-time constant	seconds
Td2	fall delay time	seconds
Tau2	fall-time constant	seconds

For times less than Td1, the output current is V1. For times between Td1 and Td2 the current is given by

$$I1 + (I2 - I1) \cdot (1 - \exp(-(\text{time} - T_{d1}) / \text{Tau1}))$$

For times after Td2 the current is given by

$$I1+(I2-I1) * (1-\exp(-(time-Td1)/Tau1)) \\ + (I1-I2) * (1-\exp(-(time-Td2)/Tau2)) .$$

Syntax: Ixxx n+ n- SFFM(Ioff Iamp Fcar MDI Fsig)

Time-dependent single-frequency FM current source.

name	parameter	units
Ioff	D.C. offset	Amps
Iamp	amplitude	Amps
Fcar	carrier frequency	Hz
MDI	modulation index	(none)
Fsig	signal frequency	Hz

The current is given by

$$Ioff+Iamp*\sin((2.*pi*Fcar*time)+MDI*\sin(2.*pi*Fsig*time)) .$$

Syntax: Ixxx n+ n- tbl=(<voltage, current>, <voltage, current>, ...)

The current can also be specified as a function of the voltage across the output nodes with a look-up table. This is useful for modeling the characteristics of a load.

Syntax: Ixxx n+ n- step(<value1>, [<value2>], [<value3>, ...]) [load]

This is a special form for the current source. The current is specified as a list of currents to use in a step load response transient analysis. In this mode, the simulation is computed until steady state is reached at the first

current in the list. Then the current is stepped to the next value in the list. The simulation proceeds until steady state is achieved at that current. Then the current is stepped to the next value and the process repeats until the list is exhausted.

Syntax: Ixxx n+ n- R=<value>

This is not a current source at all, but a resistor. It is used to model a resistive load when the load is netlisted as a current source.

Syntax: Ixxx n+ n- PWL(t1 i1 t2 i2 t3 i3...)

Arbitrary Piece-wise linear current source.

For times before t1, the current is i1. For times between t1 and t2, the current varies linearly between i1 and i2. There can be any number of time, current points given. For times after the last time, the current is the last current.

Syntax: Ixxx n+ n- wavfile=<filemane> [chan=<nnn>]

This allows a .wav file to be used as an input to LTspice. <filemane> is either a full, absolute path for the .wav file or a relative path computed from the directory containing the simulation schematic or netlist. Double quotes may be used to specify a path containing spaces. The .wav file may contain up to 65536 channels, numbered 0 to 65535. Chan may be set to specify which channel is used. By default, the first channel, number 0, is used. The .wav file is interpreted as having a full scale range from -1A to 1A.

This source only has meaning in a .tran analysis.

J. JFET transistor

Symbol Names: NJF, PJF

```
Syntax: Jxxx D G S <model> [area] [off] [IC=Vds, Vgs]
[temp=T]
```

Examples:

```
J1 0 in out MyJFETmodel
.model MyJFETmodel NJF(Lambda=.001)

J2 0 in out MyPJFETmodel
.model MyPJFETmodel PJF(Lambda=.001)
```

A JFET transistor requires a `.model` card to specify its characteristics. Note that the model card keywords NJF and PJF specify the polarity of the transistor. The area factor determines the number of equivalent parallel devices of a specified model.

The JFET model is derived from the FET model of Shichman and Hodges extended to include Gate junction recombination current and impact ionization. The DC characteristics are defined by the parameters VTO and BETA, which determine the variation of drain current with gate voltage; LAMBDA, which determines the output conductance; and Is, the saturation current of the two gate junctions. Two ohmic resistances, Rd and Rs, are included. Charge storage is modeled by nonlinear depletion layer capacitances for both gate junctions; which vary as the $-1/2$ power of junction voltage and are defined by the parameters Cgs, Cgd, and PB. A fitting parameter B has been added. See A. E. Parker and D. J. Skellern, *An Improved FET Model for Computer Simulators*, IEEE Trans CAD, vol. 9, no. 5, pp. 551-553, May 1990.

name	parameter	units	default	example
Vto	threshold voltage	V	-2.0	-2.0
Beta	transconductance parameter	A/V/V	1e-4	1e-3
Lambda	channel-length modulation parameter	1/V	0	1e-4
Rd	drain ohmic resistance	Ohm	0	100
Rs	source ohmic resistance	Ohm	0	100
Cgs	zero-bias G-S junction capacitance	F	0	5pF
Cgd	zero-bias G-D junction capacitance	F	0	1pF
PB	gate junction potential	V	1	0.6
Is	gate junction saturation current	A	1e-14	1e-14
B	doping tail parameter	-	1	1.1
KF	flicker noise coefficient	-	0	
AF	flicker noise exponent	-	1	
FC	coeff. for forward-depletion capacitance	-	0.5	
Tnom	parameter measurement temperature	°C	27	50
betatce	transconductance parameter exponential temperature coefficient	%/°C	0	
vtotc	Threshold voltage temperature coefficient	V/°C	0	
N	Gate junction emission coefficient	-	1	
Isr	Gate junction recombination current parameter	A	0	
Nr	emission coefficient for Isr	-	2	
alpha	ionization coefficient	1/V	0	
Vk	ionization knee current	V	0	
xTi	Saturation current temperature coefficient	-	3	

K. Mutual Inductance

Symbol Names: None, this is placed as text on the schematic.

Syntax: Kxxx L1 L2 [L3 ...] <coefficient>

L1 and L2 are the names of inductors in the circuit. The mutual coupling coefficient must be in the range of -1 to 1.

The line

```
K1 L1 L2 L3 L4 1.
```

is synonymous with the six lines

```
K1 L1 L2 1.  
K2 L2 L3 1.  
K3 L3 L4 1.  
K4 L1 L3 1.  
K5 L2 L4 1.  
K6 L1 L4 1.
```

It is recommended to start with a mutual coupling coefficient equal to 1. This will eliminate leakage inductance that can ring at extremely high frequencies if damping is not supplied and slow the simulation. However, a mutual inductance value of -1 or 1 can lead to simulation difficulties if the uic directive is flagged on the .tran card.

L. Inductor

Symbol Names: IND, IND2

Syntax: Lxxx n+ n- <inductance> [ic=<value>]
+ [Rser=<value>] [Rpar=<value>]

+ [Cpar=<value>] [m=<value>]

It is possible to specify an equivalent series resistance, series inductances, parallel resistance and parallel shut capacitance. The equivalent circuit is given below:

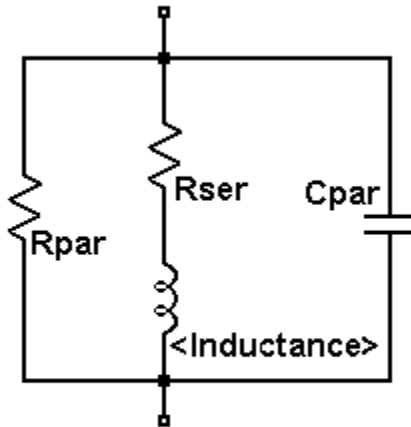

Inductor Instance Parameters

name	parameter
Rser	equivalent series resistance
Rpar	equivalent parallel resistance
Cpar	equivalent parallel capacitance
m	number of parallel units
ic	initial current(used only if uic
	is flagged on the .tran card)

It is better to include the device parasitics Rpar, Rser, and Cpar in the inductor than to explicitly draft them. LTspice uses proprietary circuit simulation technology to simulate this physical capacitor without any internal nodes. This makes the simulation matrix smaller, faster to compute and less likely to be singular over all time-step sizes.

By default, LTspice will supply losses to inductors to aid SMPS transient analysis. For SMPS, these losses are of usually of no consequence, but may be turned off if desired. On the "Tools=> Control Panel=>Hacks!" page, uncheck "Supply a min. inductor damping if no Rpar is given." This setting will be remembered between invocations of the program. There is also a default series resistance of 1 milliOhm for inductors that aren't mentioned in a mutual inductance statement. This Rser allows SwitcherCAD III to integrate the inductance as a Norton equivalent circuit instead of Thevenin equivalent in order to reduce the size of the circuit's linearized matrix. If you don't want LTspice to introduce this minimum resistance, you must explicitly set Rser=0 for that inductor. This will require LTspice to use the more cumbersome Thevenin equivalent of the inductor during transient analysis.

M. MOSFET

Symbol Names: NMOS, NMOS3, PMOS, PMOS3 There are two fundamentally different types of MOSFETS in LTspice, monolithic MOSFETS and a new vertical doubly diffused power MOSFET model.

Monolithic MOSFET:

```
Syntax:  Mxxx Nd Ng Ns Nb <model> [m=<value>] [L=<len>]
         + [W=<width>] [AD=<area>] [AS=<area>]
         + [PD=<perim>] [PS=<perim>] [NRD=<value>]
         + [NRS=<value>] [off] [IC=<Vds, Vgs, Vbs>]
         + [temp=<T>]
```

```
M1 Nd Ng Ns 0 MyMOSFET
```

```
.model MyMOSFET NMOS (KP=.001)
```

```
M1 Nd Ng Ns Nb MypMOSFET
.model MypMOSFET PMOS(KP=.001)
```

Vertical doubly diffused power MOSFET:

```
Syntax: Mxxx Nd Ng Ns <model> [L=<len>] [W=<width>]
        + [M=<area>] [m=<value>] [off]
        + [IC=<Vds, Vgs, Vbs>] [temp=<T>]
```

Example:

```
M1 Nd Ng Ns Si4410DY
.model Si4410DY VDMOS(Rd=3m Rs=3m Vto=2.6 Kp=60
+ Cgdmax=1.9n Cgdmin=50p Cgs=3.1n Cjo=1n
+ Is=5.5p Rb=5.7m)
```

The MOSFET's model card specifies which type is intended. The model card keywords NMOS and PMOS specify a monolithic N- or P- channel MOSFET transistor. The model card keyword VDMOS specifies a vertical doubly diffused power MOSFET.

Monolithic MOSFETS are four terminal devices. Nd, Ng, NS, and Nb are the drain, gate, source, and bulk; i.e., substrate; nodes. L and W are the channel length and width, in meters. AD and AS are the areas of the drain and source diffusions, in square meters. Note that the suffix u specifies μm and p square μm . If any of L, W, AD, or AS are not specified, default values are used. PD and PS are the perimeters of the drain and source junctions, in meters. NRD and NRS designate the equivalent number of squares of the drain and source diffusions; these values multiply the sheet resistance RSH specified on the .MODEL control line. PD and PS default to zero while NRD and NRS to one. OFF indicates an initial condition on the device for DC analysis. The initial condition specification using IC=VDS, VGS, VBS is for use with the UIC option on the .TRAN control line, when a transient analysis is desired starting from other than the quiescent

operating point. The optional TEMP value is the temperature at which this device is to operate, and overrides the temperature specification on the .OPTION control line. The temperature specification is ONLY valid for level 1, 2, 3, and 6 MOSFETs, not for level 4, 5 or 8 BSIM devices.

LTspice contains seven different types of monolithic MOSFET's and one type of vertical doubly diffused Power MOSFET.

There are seven monolithic MOSFET device models. The model parameter LEVEL specifies the model to be used. The default level is one.

level	model
1	Shichman-Hodges
2	MOS2 (see A. Vladimirescu and S. Liu, The Simulation of MOS Integrated Circuits Using SPICE2, ERL Memo No. M80/7, Electronics Research Laboratory University of California, Berkeley, October 1980)
3	MOS3, a semi-empirical model (see reference for level 2)
4	BSIM (see B. J. Sheu, D. L. Scharfetter, and P. K. Ko, SPICE2 Implementation of BSIM. ERL Memo No. ERL M85/42, Electronics Research Laboratory University of California, Berkeley, May 1985)
5	BSIM2 (see Min-Chie Jeng, Design and Modeling of Deep-Submicrometer MOSFETs ERL Memo Nos. ERL M90/90,

Electronics Research Laboratory University of
California, Berkeley, October 1990)

- 6 MOS6 (see T. Sakurai and A. R. Newton, A Simple MOSFET Model for Circuit Analysis and its application to CMOS gate delay analysis and series-connected MOSFET Structure, ERL Memo No. ERL M90/19, Electronics Research Laboratory, University of California, Berkeley, March 1990)

- 8 BSIM3. version of BSIM3v3.2.4 from University of California, Berkeley as of December 2001.

- 9 BSIMPD2.2.3 (SOI -- Silicon on insulator) from the BSIM Research Group of the University of California, Berkeley, March 2002.

- 12 EKV 2.6. Based on code from Ecole Polytechnique Federale de Lausanne. See <http://legwww.epfl.ch/ekv> and "The EPFL-EKV MOSFET Model Equations for Simulation, Version 2.6", M. Bucher, C. Lallement, F. Theodoloz, C. Enz, F. Krummenacher, EPFL-DE-LEG, June 1997.

- 14 BSIM4.2.1 from the University of California, Berkeley BSIM Research Group, October 2001.

The DC characteristics of the level 1 through level 3 MOSFETs are defined by the device parameters VTO, KP, LAMBDA, PHI and GAMMA. These parameters are computed if the process parameters(NSUB, TOX,...) are given, but user-specified values always override. VTO is positive (negative) for enhancement mode and negative (positive) for depletion mode N-channel (P-channel) devices. Charge storage is modeled by three constant capacitors, CGSO, CGDO, and CGBO which represent overlap capacitances, by the non-linear thin-oxide capacitance which is distributed among the gate, source, drain, and bulk regions, and by the

nonlinear depletion-layer capacitances for both substrate junctions divided into bottom and periphery, which vary as the MJ and MJSW power of junction voltage respectively, and are determined by the parameters CBD, CBS, CJ, CJSW, MJ, MJSW and PB. Charge storage effects are modeled by the piecewise linear voltages-dependent capacitance model proposed by Meyer. The thin-oxide charge-storage effects are treated slightly different for the Level=1 model. These voltage dependent capacitances are included only if Tox is specified.

There is some overlap among the parameters describing the junctions, e.g., the reverse current can be specified either through Is[Amp] or through Js[Amp/m/m]. Whereas the first is an absolute value the second is multiplied by Ad and As to give the reverse current of the drain and source junctions respectively. The same idea applies also to the zero-bias junction capacitances CBD and CBS[Farad] on one hand, and CJ[Farad/m/m] on the other. The parasitic drain and source series resistance can be expressed as either RD and RS[Ohms] or RSH[Ohms/square], the latter being multiplied by the number of squares NRD and NRS input on the device line.

MOSFET level 1, 2, 3 and 6 parameters:

name	parameter	units	default	example
VTO	zero-bias threshold voltage	V	0.	1.
KP	transconductance parameter	A/V/V	2e-5	3e-5
GAMMA	bulk threshold parameter	sqrt(V)	0.	0.37
PHI	surface potential	V	0.6	0.65
LAMBDA	channel-length modulation(level 1 and 2 only)	1/V	0.	0.02
Rd	drain ohmic resistance	Ohms	0.	1.
Rs	source ohmic resistance	Ohms	0.	1.
Cbd	zero-bias B-D junction capacitance	F	0.	20f
Cbs	zero-bias B-S junction	F	0.	20f

	capacitance			
Is	bulk junction saturation current	A	1e-14	1e-15
Pb	bulk junction potential	V	0.8	0.87
Cgso	gate-source overlap capacitance per meter channel width	F/m	0.	4e-11
Cgdo	gate-drain overlap capacitance per meter channel width	F/m	0.	4e-11
Cgbo	gate-bulk overlap capacitance per meter channel length	F/m	0.	2e-10
Rsh	drain and source diffusion sheet resistance	Ohms	0.	10.
Cj	zero-bias bulk junction bottom capacitance per sq-meter of junction area	F/m/m	0.	2e-4
Mj	bulk junction bottom grading coefficient	-	0.5	0.5
Cjsw	zero-bias bulk junction sidewall capacitance per meter of junction perimeter	F/m	0.	1e-9
Mjsw	bulk junction sidewall grading coefficient	-	0.50 level 1	0.33 level 2,3
Js	bulk junction saturation current per sq-meter of junction area	A/m	0.	1e-8
Tox	oxide thickness	m	1e-7	1e-7
Nsub	substrate doping	1/cm/cm/cm	0.	4e15
Nss	surface state density	1/cm/cm	0.	1e10
Nfs	fast surface state density	1/cm/cm	0.	1e10
TPG	type of gate material: +1 opp. to substrate -1 same as substrate 0 Al gate	-	1.	
XJ	metallurgical junction depth	m	0.	1μ
LD	lateral diffusion	m	0.	0.8μ
UO	surface mobility	cm*cm/V/s	600	700
Ucrit	critical field for mobility degradation (MOS2 only)	V/cm	1e4	1e4

Uexp	critical field exponent in mobility degradation (MOS2 only)	-	0.	0.1
UTRA	transverse field coefficient (mobility) (deleted for MOS2)	-	0.	0.3
Vmax	maximum drift velocity of carriers	m/s	0.	5e4
Neff	total channel-charge (fixed and mobile) coefficient (MOS2 only)	-	1.	5.0
KF	flicker noise coefficient	-	0.	1e-26
AF	flicker noise exponent	-	1.	1.2
FC	coefficient for forward- bias depletion capacitance formula	-	0.5	
DELTA	width effect on threshold voltage(MOS2 and MOS3)	-	0.	1.
THETA	mobility modulation(MOS3 only)	1/V	0.	0.1
ETA	static feedback (MOS3 only)	-	0.	1.
KAPPA	saturation field factor(MOS3 only)	-	0.2	0.5
Tnom	parameter measurement temperature	°C	27	50

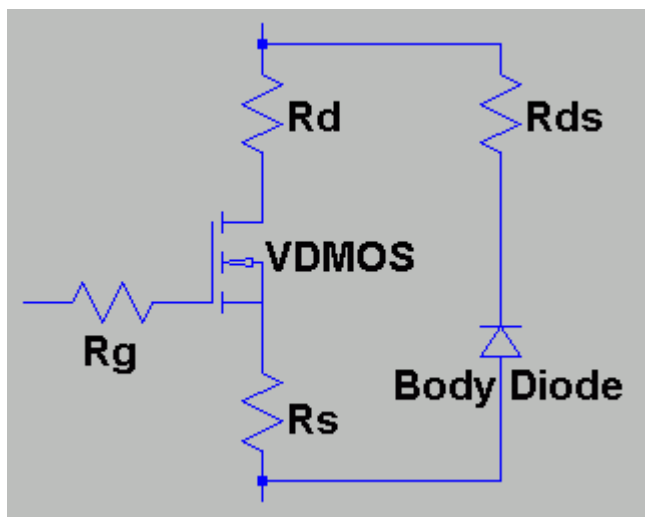

The discrete vertical doubly diffused MOSFET transistor(VDMOS) popularly used in board level switchmode power supplies has behavior that is qualitatively different than the above monolithic

MOSFET models. In particular, (i) the body diode of a VDMOS transistor is connected differently to the external terminals than the substrate diode of a monolithic MOSFET and (ii) the gate-drain capacitance (C_{gd}) non-linearity cannot be modeled with the simple graded capacitances of monolithic MOSFET models. In a VDMOS transistor, C_{gd} abruptly changes about zero gate-drain voltage (V_{gd}). When V_{gd} is negative, C_{gd} is physically based a capacitor with the gate as one electrode and the drain on the back of the die as the other electrode. This capacitance is fairly low due to the thickness of the non-conducting die. But when V_{gd} is positive, the die is conducting and C_{gd} is physically based on a capacitor with the thickness of the gate oxide.

Traditionally, elaborate subcircuits have been used to duplicate the behavior of a power MOSFET. A new intrinsic spice device was written that encapsulates this behavior in the interest of compute speed, reliability of convergence, and simplicity of writing models. The DC model is the same as a level 1 monolithic MOSFET except that the length and width default to one so that transconductance can be directly specified without scaling. The AC model is as follows. The gate-source capacitance is taken as constant. This was empirically found to be a good approximation for power MOSFETS if the gate-source voltage is not driven negative. The gate-drain capacitance follows the following empirically found form:

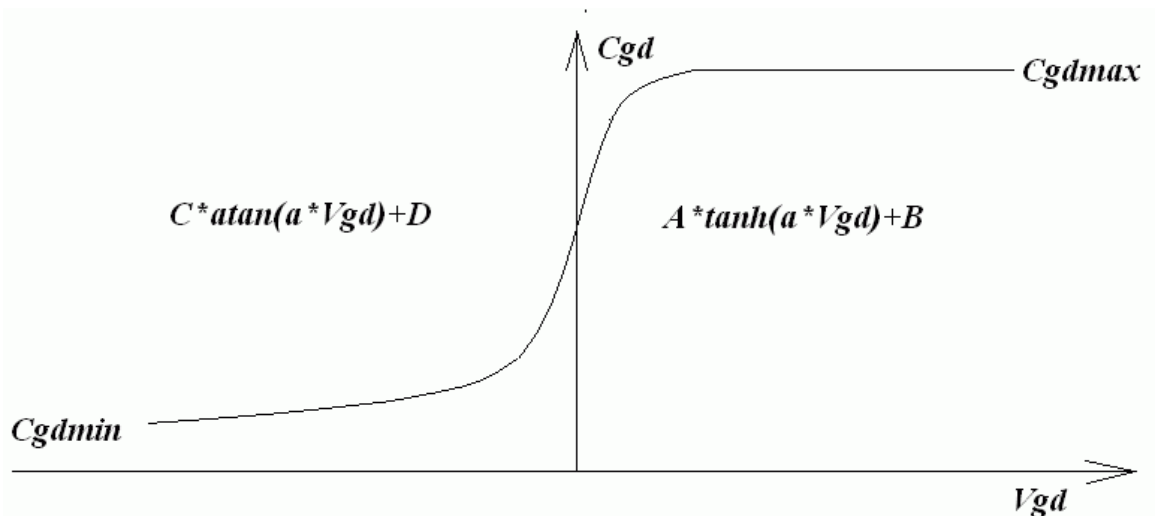

For positive V_{gd} , C_{gd} varies as the hyperbolic tangent of V_{gd} . For negative V_{gd} , C_{gd} varies as the arc tangent of V_{gd} . The model parameters a , C_{gdmax} , and C_{gdmin} parameterize the gate drain capacitance. The source-drain capacitance is supplied by the graded capacitance of a body diode connected across the source drain electrodes, outside of the source and drain resistances.

name	parameter	units	default	example
l	Length	m	1.	2.
w	Width	m	1.	1.
R_g	Gate ohmic resistance	Ohms	0.	
R_{ds}	Drain-Source shunt resistance	Ohms	0.	
V_{TO}	zero-bias threshold voltage	V	0.	1.
K_P	transconductance	A/V	1.	3.
GAMMA	bulk threshold parameter	sqrt(V)	0.	0.37
PHI	surface potential	V	0.6	0.65
LAMBDA	channel-length modulation	1/V	0.	0.02
C_{bd}	zero-bias B-D junction capacitance	F	0.	20f
C_{bs}	zero-bias B-S junction capacitance	F	0.	20f
R_d	Drain ohmic resistance	Ohms	0.	
R_s	Source ohmic resistance	Ohms	0.	
C_{gs}	Gate-source overlap capacitance	F	0.	4e-11
C_{gdmin}	Minimum non-linear G-D capacitance	F	0.	4e-11
C_{gdmax}	Maximum non-linear G-D capacitance	F	0.	4e-11
a	non-linear C_{gd} capacitance parameter	1	1.	.5
I_s	Bulk diode saturation current	A	1e-14	1e-15
R_b	Bulk diode ohmic resistance	Ohms	0.	
n	Body diode emission coefficient	Ohms	0.	
C_{jo}	Body diode junction capacitance	F	0.	4e-11

Vj	Body diode junction potential	V	0.75	
m	Body diode grading coefficient	-	0.5	0.5
Fc	Body diode forward bias junction fit parameter	-	0.5	
tt	Body diode transit time	sec	0.	0.1n
Eg	Body diode activation energy for temperature effect on Is	eV	1.11	
Xti	Body diode saturation current temperature exponent	-	3	
nchan[*]	N-channel VDMOS	-	(true)	
pchan[*]	P-channel VDMOS	-	(false)	
Tnom	Parameter measurement temperature	°C	27	
Kf	Flicker noise coefficient	-	0	
Af	Flicker noise exponent	-	0	

*]The model name VDMOS is used both for a N-channel and P-channel device. The polarity defaults to N-channel. To specify P-channel, flag the model with the keyword "pchan", e.g., ".model xyz VDMOS(Kp = 3 pchan)" defines a P-channel transistor.

O. Lossy Transmission Line

Symbol Names: RES, RES2

Syntax: Oxxx L+ L- R+ R- <model>

Example:

```
O1 in 0 out 0 MyLossyTline
.model MyLossyTline LTRA(len=1 R=10 L=1u C=10n)
```

This is a single-conductor lossy transmission line. N1 and N2 are the nodes at port 1. N3 and N4 are the nodes at port 2. A model card is required to define the electrical characteristics of this circuit element.

Model parameters for Lossy Transmission Lines

name	parameter	units/type	default
R	resistance/length	Ohm/unit	0.
L	inductance/length	Henrys/unit	0.
G	conductance/length	mhos/unit	0.
C	capacitance/length	Farads/unit	0.
LEN	length of line		(none)
REL	breakpoint control	-	1
ABS	breakpoint control		1
NOSTEPLIMIT	don't limit time-step to less than line delay	flag	not set
NOCONTROL	don't do complex time-step control	flag	not set
LININTERP	use linear interpolation	flag	not set
MIXEDINTERP	use linear interpolation when quadratic seems bad	flag	not set
COMPACTREL	special reltol for history compaction	flag	RELTOL
COMPACTABS	special abstol for history compaction		ABSTOL
TRUNCNR	use Newton-Raphson method for time-step control	flag	not set
TRUNCDONTCUT	don't limit time-step to keep impulse-response errors low	flag	not set

Q. Bipolar transistor

Symbol Names: NPN, PNP, NPN2, PNP2

Syntax: Qxxx Collector Base Emitter [Substrate Node] model
[area]
+ [off] [IC=<Vbe, Vce>]
[temp=<T>]

Example:

```
Q1 C B E MyNPNmodel  
.model MyNPNmodel NPN(Bf=75)
```

Bipolar transistors require a model card to specify its characteristics. The model card keywords NPN and PNP indicate the polarity of the transistor. The area factor determines the number of equivalent parallel devices of a specified model.

The bipolar junction transistor model is an adaptation of the integral charge control model of Gummel and Poon. This modified Gummel-Poon model extends the original model to include several effects at high bias levels, quasi-saturation, and substrate conductivity. The model automatically simplifies to the Ebers-Moll model when certain parameters are not specified. The DC model is defined by the parameters I_s , B_f , N_f , I_{se} , I_{kf} , and N_e which determine the forward current gain characteristics, I_s , B_r , N_r , I_{sc} , I_{kr} , and N_c which determine the reverse current gain characteristics, and V_{af} and V_{ar} which determine the output conductance for forward and reverse regions. Three ohmic resistances R_b , R_c and R_e , are included, where R_b can be high current dependent. Base charge storage is modeled by forward and reverse transit times, T_f and T_r , the forward transit time T_f being bias dependent if desired; and nonlinear depletion layer capacitances, which are determined by C_{je} , V_{je} and M_{je} , for the B-E junction, C_{jc} , V_{jc} , and M_{jc} for the B-C junction and C_{js} , V_{js} , and M_{js} for the Collector-Substrate junction. The temperature dependence of the saturation current, I_s , is determined by the energy gap, E_g , and the saturation-current temperature

exponent, XTI. Additionally base current temperature dependence is modeled by the beta temperature exponent XTB in the new model. The values specified are assumed to have been measured at the temperature TNOM, which can be specified on the .OPTIONS control line or overridden by a specification on the .model line.

The BJT parameters used in the modified Gummel-Poon model are listed below.

Modified Gummel-Poon BJT Parameters

name	parameter	units	default
Is	transport saturation current	A	1.0e-16
Bf	ideal maximum forward beta	-	100
Nf	forward current emission coefficient	-	1.0
Vaf	forward Early voltage	V	infinite
Ikf	corner for forward beta		
	high current roll-off	A	infinite
Ise	B-E leakage saturation current	A	0
NE	B-E leakage emission coefficient	-	1.5
Br	ideal maximum reverse beta	-	1
Nr	reverse current emission coefficient	-	1
Var	reverse Early voltage	V	infinite
Ikr	corner for reverse beta		
	high current roll-off	A	infinite
Isc	B-C leakage saturation current	A	0
Nc	B-C leakage emission coefficient	-	2
Rb	zero bias base resistance	Ohm	0
Irb	current where base resistance		
	falls halfway to its min value	A	infinite
Rbm	minimum base resistance		
	at high currents	Ohm	RB
Re	emitter resistance	Ohm	0
Rc	collector resistance	Ohm	0
Cje	B-E zero-bias depletion capacitance	F	0
Vje	B-E built-in potential	V	0.75
Mje	B-E junction exponential factor	-	0.33
Tf	ideal forward transit time	sec	0
Xtf	coefficient for bias dependence of TF	-	0
Vtf	voltage describing VBC		
	dependence of TF	V	infinite

Itf	high-current parameter for effect on TF	A	0
PTF	excess phase at freq=1.0/(TF*2PI) Hz	°	0
Cjc	B-C zero-bias depletion capacitance	F	0
Vjc	B-C built-in potential	V	0.75
Mjc	B-C junction exponential factor	-	0.33
Xcjc	fraction of B-C depletion capacitance connected to internal base node	-	1
Tr	ideal reverse transit time	sec	0
Cjs	zero-bias collector-substrate capacitance	F	0
Vjs	substrate junction built-in potential	V	0.75
Mjs	substrate junction exponential factor	-	0
Xtb	forward and reverse beta temperature exponent	-	0
Eg	energy gap for temperature effect on IS	eV	1.11
Xti	temperature exponent for effect on IS	-	3
Kf	flicker-noise coefficient	-	0
Af	flicker-noise exponent	-	1
Fc	coefficient for forward-bias depletion capacitance formula	-	0.5
Tnom	Parameter measurement temperature	°C	27
cn	Quasi-saturation temperature coefficient for hole mobility		2.42 NPN 2.2 PNP
d	Quasi-saturation temperature coefficient for scattering- limited hole carrier velocity		.87 NPN .52 PNP
gamma	epitaxial region doping factor		1e-11
qco	epitaxial region charge factor	Coul	0
quasimod	Quasi-saturation flag for temperature dependence	-	0
rco	epitaxial region resistance	Ohm	0
vg	Quasi-saturation extrapolated bandgap voltage at 0°K	V	1.206
vo	carrier mobility knee voltage	V	10.
Tre1	Re linear temperature coefficient	/°C	0
Tre2	Re quadratic temperature coefficient	/°C/°C	0
Trb1	Rb linear temperature coefficient	/°C	0
Trb2	Rb quadratic temperature coefficient	/°C/°C	0
Trc1	Rc linear temperature coefficient	/°C	0
Trc2	Rmb quadratic temperature coefficient	/°C/°C	0
Trm1	Rmb linear temperature coefficient	/°C	0

Trm2	Rc quadratic temperature coefficient	/°C/°C	0
Iss	Substrate junction saturation current	A	0
Ns	Substrate junction emission coefficient	-	1

R. Resistor

Symbol Names: RES, RES2

Syntax: Rxxx n1 n2 <value> [tc=tc1, tc2, ...]

The resistor supplies a simple linear resistance between nodes n1 and n2. A temperature dependence can be defined for each resistor instance with the parameter tc. The resistance, R, at will be

$$R = R0 * (1. + dt * tc1 + dt**2 * tc2 + dt**3 * tc3 + \dots)$$

where R0 is the resistance at the nominal temperature and dt is the difference between the resistor's temperature and the nominal temperature.

S. Voltage Controlled Switch

Symbol Names: SW

Syntax: Sxxx n1 n2 nc+ nc- <model> [on,off]

Example:

S1 out 0 in 0 MySwitch

```
.model MySwitch SW(Ron=.1 Roff=1Meg Vt=0 Vh=-.5 Lser=10n
Vser=.6)
```

The voltage between nodes nc+ and nc- controls the switch's impedance between nodes n1 and n2. A model card is required to define the behavior of the switch. See the schematic file `.\examples\Educational\Vswitch.asc` to see an example of a model card placed directly on a schematic as a SPICE directive.

Voltage Controlled Switch Model Parameters

name	parameter	units	default
Vt	threshold voltage	Volts	0.
Vh	hysteresis voltage	Volts	0.
Ron	on resistance	Ohms	1.
Roff	off resistance	Ohms	1/gmin
Lser	series inductance	Henry	0.
Vser	series voltage	Volts	0.
ilimit	current limit	Amps	infin.

The switch has three distinct modes of voltage control, depending on the value of the hysteresis voltage, V_h . If V_h is zero, the switch is always completely on or off depending upon whether the input voltage is above the threshold. If V_h is positive, the switch shows hysteresis, as if it was controlled by a Schmitt trigger with trip points at $V_t - V_h$ and $V_t + V_h$. Note that V_h is half the voltage between trip points which is different than the common laboratory nomenclature. If V_h is negative, the switch will smoothly transition between the on and off impedances. The transition occurs between the control voltages of $V_t - V_h$ and $V_t + V_h$. The smooth transition follows a low order polynomial fit to the logarithm of the switch's conduction.

T. Lossless Transmission Line

Symbol Name: TLINE

Syntax: Txxx L+ L- R+ R- Zo=<value> Td=<value>

L+ and L- are the nodes at one port. R+ and R- are the nodes for the other port. Zo is the characteristic impedance. The length of the line is given by the propagation delay Td.

This element models only one propagation mode. If all four nodes are distinct in the actual circuit, then two modes may be excited. To simulate such a situation, two transmission-line elements are required.

U. Uniform RC-line

Symbol Names: URC

Syntax: Uxxx N1 N2 Ncom <model> L=<len> [N=<lumps>]

N1 and N2 are the two element nodes the RC line connects, whereas Ncom is the node to which the capacitances are connected. MNAME is the model name and LEN is the length of the RC line in meters. Lumps, if specified, is the number of lumped segments to use in modeling the RC line. A guess at an appropriate number of lumps to use will be made if lumps is not specified.

The URC model is derived from a model proposed by L. Gertzberg in 1974. The model is accomplished by a subcircuit-type expansion of the URC line into a network of lumped RC segments with internally generated nodes. The RC segments are in a geometric progression, increasing toward the middle of the URC line, with K as a proportionality constant.

The URC line is made up strictly of resistor and capacitor segments unless the ISPERL parameter is given a nonzero value, in which case the capacitors are replaced with reverse-biased diodes with a zero-bias junction capacitance equivalent to the capacitance replaced, and with a saturation current of ISPERL amps per meter of transmission line and an optional series resistance equivalent to RSPERL ohms per meter.

name	parameter	units	default
K	Propagation Constant	(none)	2.
FMAX	Maximum Frequency of interest	Hz	1G
RPERL	Resistance per unit length	Ohm/m	1000
CPERL	Capacitance per unit length	F/m	1e-15
ISPERL	Saturation Current/unit length	A/m	0
RSPERL	Diode Resistance/unit length	Ohm/m	0

V. Voltage Source

Symbol Names: VOLTAGE, BATTERY

Syntax: Vxxx n+ n- <voltage> [AC=<amplitude>]
 + [Rser=<value>] [Cpar=<value>]

This element sources a constant voltage between nodes n+ and n-. For AC analysis, the value of AC is used as the amplitude of the source at the analysis frequency. A series resistance and parallel capacitance can be defined. The equivalent circuit is:

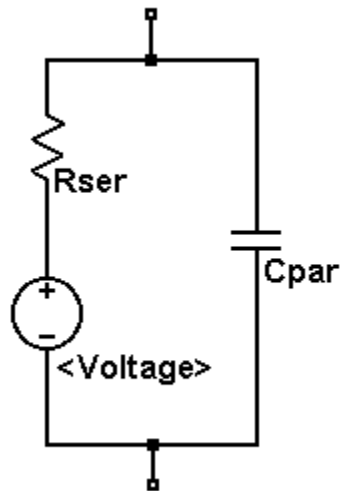

Voltage sources have historically been used as the current meters in SPICE and are used as current sensors for current-controlled elements. If Rser is specified, the voltage source can not be used as a sense element for F, H, or W elements. However, the current of any circuit element, including the voltage source, can be plotted.

Syntax: Vxxx n+ n- PULSE(V1 V2 Tdelay Trise Tfall Ton Tperiod Ncycles)

Time-dependent pulsed voltage source

name	parameter	units
Voff	initial value	Volts
Von	pulsed value	Volts
Tdelay	delay	seconds
Tr	rise time	seconds
Tf	fall time	seconds
Ton	on time	seconds
Tperiod	period	seconds
Ncycles	number of cycles wave	cycles

Syntax: Vxxx n+ n- SINE(Voffset Vamp Freq Td Theta Phi Ncycles)

Time-dependent sine wave voltage source.

name	parameter	units
Voffset	DC offset	Volts
Vamp	amplitude	Volts
Freq	frequency	Hz
Td	delay	seconds
Theta	damping factor	1/seconds
Phi	phase	degrees
Ncycles	number of cycles wave	cycles

For times less than Td or times after completing Ncycles, have run, the output voltage is given by

$$Voffset + Vamp * \sin(\pi * \Phi / 180)$$

Otherwise the voltage is given by

$$Voffset + Vamp * \exp(-(\text{time} - Td) * \Theta) * \sin(2 * \pi * \text{Freq} * (\text{time} - Td) + \pi * \Phi / 180)$$

The damping factor, Theta, is the reciprocal of the decay time constant.

Syntax: Vxxx n+ n- EXP(V1 V2 Td1 Tau1 Td2 Tau2)

Time-dependent exponential voltage source

name	parameter	units
V1	initial value	Volts
V2	pulsed value	Volts
Td1	rise delay time	seconds
Tau1	rise-time constant	seconds
Td2	fall delay time	seconds
Tau2	fall-time constant	seconds

For times less than Td1, the output voltage is V1. For times between Td1 and Td2 the voltage is given by

$$V1 + (V2 - V1) * (1 - \exp(-(time - Td1) / Tau1)).$$

For times after Td2 the voltage is given by

$$V1 + (V2 - V1) * (1 - \exp(-(time - Td1) / Tau1)) \\ + (V1 - V2) * (1 - \exp(-(time - Td2) / Tau2)).$$

Syntax: Vxxx n+ n- SFFM(Voff Vamp Fcar MDI Fsig)

Time-dependent single frequency FM voltage source.

name	parameter	units
Voff	D.C. offset	Volts
Vamp	amplitude	Volts
Fcar	carrier frequency	Hz
MDI	modulation index	(none)
Fsig	signal frequency	Hz

The voltage is given by

$$Voff + Vamp * \sin((2.*pi*Fcar*time) + MDI * \sin(2.*pi*Fsig*time)).$$

Syntax: Vxxx n+ n- PWL(t1 v1 t2 v2 t3 v3...)

Arbitrary Piece-wise linear voltage source.

For times before t1, the voltage is v1. For times between t1 and t2, the voltage varies linearly between v1 and v2. There can be any number of time, voltage points given. For times after the last time, the voltage is the last voltage.

Syntax: Vxxx n+ n- wavefile=<filemane> [chan=<nnn>]

This allows a .wav file to be used as an input to LTspice. <filemane> is either a full, absolute path for the .wav file or a relative path computed from the directory containing the simulation schematic or netlist. Double quotes may be used to specify a path containing spaces. The .wav file may contain up to 65536 channels, numbered 0 to 65535. Chan may be set to specify which channel is used. By default, the first channel, number 0, is used. The .wav file is interpreted as having a full scale range from -1V to 1V.

This source only has meaning in a .tran analysis.

W. Current Controlled Switch

Symbol Names: CSW

Syntax: Wxxx n1 n2 Vnam <model> [on,off]

Example:

```
W1 out 0 Vsense MySwitch
```

```
Vsense a b 0.
```

```
.model MySwitch CSW(Ron=.1 Roff=1Meg It=0 Ih=-.5)
```

The current through the named voltage source controls the switch's impedance. A model card is required to define the behavior of the current controlled switch.

Current Controlled Switch Model Parameters

name	parameter	units	default
It	threshold current	Volts	0.
Ih	hysteresis current	Volts	0.
Ron	on resistance	Ohms	1.
Roff	off resistance	Ohms	1/gmin

The switch has three distinct modes of current control, depending on the value of the hysteresis current, I_h . If I_h is zero, the switch is always completely on or off according to whether the control current is above threshold. If I_h is positive, the switch shows hysteresis with trip point currents at $I_t - I_h$ and $I_t + I_h$. If I_h is negative, the switch will smoothly transition between the on and off impedances. The transition occurs between the control currents of $I_t - I_h$ and $I_t + I_h$. The smooth transition follows a low order polynomial fit to the logarithm of the switch's conduction.

X. Subcircuit

Symbol Names:

LT1001	LT1006	LT1028	LT1070
LT1071			
LT1072	LT1074	LT1109-12	LT1109-5
LT1109			
LT1109A-12	LT1109A-5	LT1109A	LT1112
LT1124			
LT1169	LT1170	LT1170HV	LT1171
LT1171HV			
LT1172	LT1172HV	LT1211	LT1227
LT1300			
LT1301	LT1302-5	LT1302	LT1303-5
LT1303			
LT1304-3.3	LT1304-5	LT1304	LT1305
LT1307			
LT1307b	LT1309	LT1316	LT1317
LT1317b			

LT1351	LT1371	LT1372	LT1375-5
LT1375			
LT1376-5	LT1376	LT1377	LT1413
LT146			
LT1490	LT1498	LT1533	LT1610
LT1611			
LT1613	LT1614	LT1627	LT1676
LT1735			
LTC1047	LTC1174-3.3	LTC1174-5	LTC1174
LTC1174HV-3.3			
LTC1174HV-5	LTC1174HV	LTC1625	LTC1628
LTC1736			

(and others)

Syntax: `Xxxx n1 n2 n3... <subckt name>`
`[<parameter>=<expression>]`

Subcircuits allow circuitry to be defined and stored in a library for later retrieval by name. Below is an example of defining and calling a voltage divider and invoking it in a circuit.

```
* calling a subcircuit
*
* This is the circuit
X1 in out 0 divider top=9K bot=1K
V1 in 0 pulse(0 1 0 .5m .5m 0 1m)

* This is the subcircuit
.subckt divider A B C
R1 A B {top}
R2 B C {bot}
.ends divider
.tran 3m
.end
```

Z. MESFET transistor

Symbol Names: MESFET

Syntax: Zxxx D G S model [area] [off] [IC=<Vds, Vgs>]

A MESFET transistor requires a model card to specify its characteristics. The model card keywords NMF and PMF specify the polarity of the transistor. The MESFET model is derived from the GaAs FET model described in H. Statz et al., GaAs FET Device and Circuit Simulation in SPICE, IEEE Transactions on Electron Devices, V34, Number 2, February, 1987 pp160-169.

Two ohmic resistances, Rd and Rs, are included. Charge storage is modeled by total gate charge as a function of gate-drain and gate-source voltages and is defined by the parameters CGS, CGD, and PB.

name	parameter	units	default
VTO	pinch-off voltage	V	-2.
BETA	transconductance parameter	A/V/V	1e-4
B	doping tail extending parameter	1/V	.3
ALPHA	saturation voltage parameter	1/V	2
LAMBDA	channel-length modulation	1/V	0
RD	drain ohmic resistance	Ohms	0
RS	source ohmic resistance	Ohms	0
CGS	zero-bias G-S junction capacitance	F	0
CGD	zero-bias G-D junction capacitance	F	0
PB	gate junction potential	V	1
KF	flicker noise coefficient	(none)	0
AF	flicker noise exponent	(none)	1
FC	forward-bias depletion coefficient	(none)	.5

Control Panel

Accessing the Control Panel

To get to the Control Panel, use the menu command Tools=>Control Panel. There you can configure many aspects of LTspice/SwitcherCAD III.

Compression

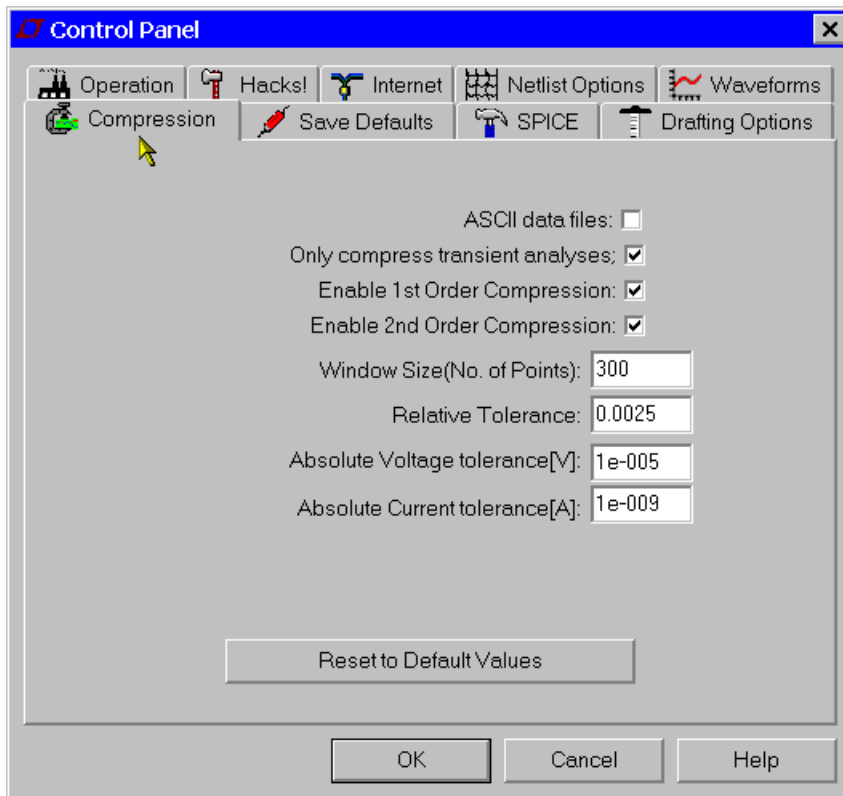

LTspice compresses the raw data files as they are generated. A compressed file can be 50 times smaller than the un-compressed one. This is a lossy compression. This pane of the control panel allows you to control how lossy the compression runs.

Window Size(No. of Points): Maximum number of points that can be compressed into two end points.

Relative Tolerance: The relative error allowed between the compressed data and the uncompressed data.

Absolute Voltage tolerance[V]: The voltage error allowed by the compression algorithm.

Absolute Current tolerance[A]: The current error allowed by the compression algorithm.

File Size Vs Fidelity study:

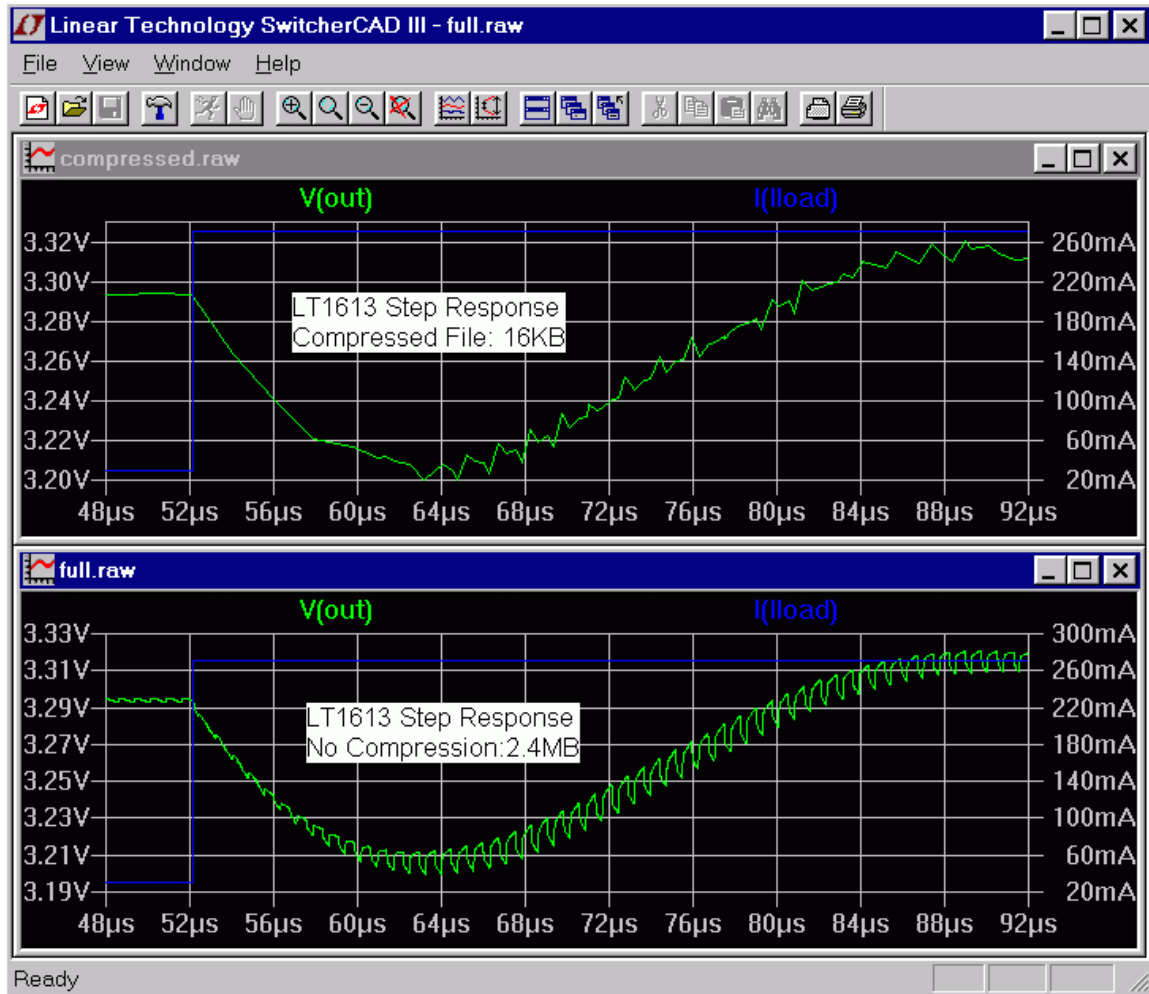

Operation

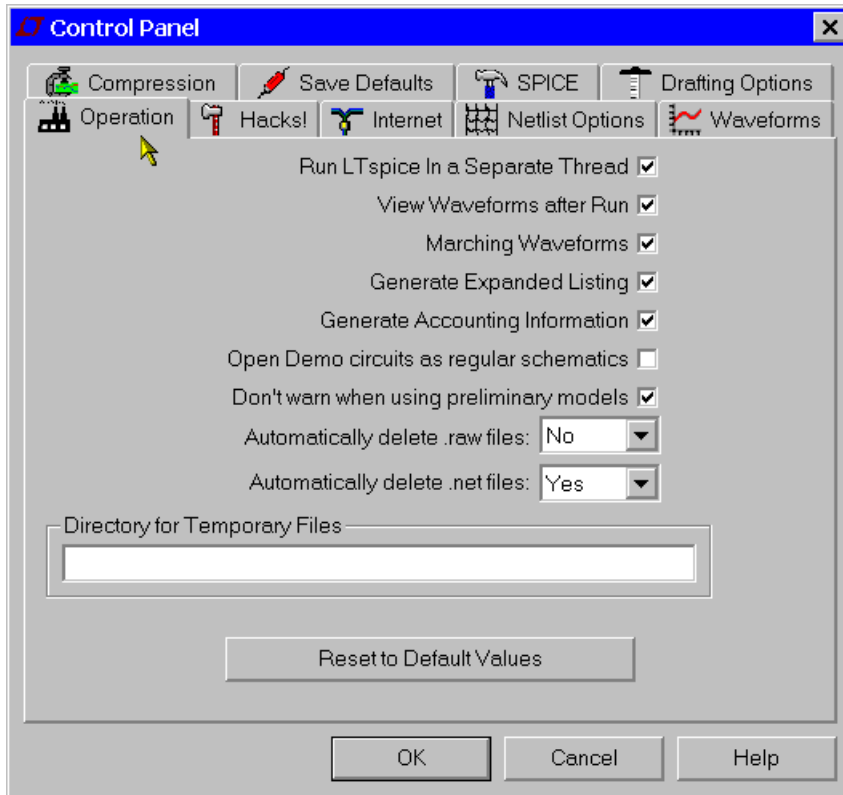

Run LTspice in a Separate Thread: It should always be checked.

View Waveforms after Run: A waveform window will be displayed after the simulation is completed. This is a useful option when marching waveforms are not selected.

Marching Waveforms: To show the incremental progress of the simulation. Normally this should be checked.

Generate Expanded Listing: Dump the flat netlist after expanding subcircuits to the in the **SPICE Error Log** file.

Open Demo circuits as regular schematics: Use [File] [Open] to open demo circuits in `.\SwCADIII\lib\app*.app`. All SPICE commands will be visible. The schematic can be edited and saved to a new file. The double dots '..' is for demo

circuit display control use. Only one dot is required for editing.

Don't warn when using preliminary models: Turn off the warning message for all preliminary models.

Directory for Temporary Files: Turn off the warning message for all preliminary models.

Save Defaults

These settings are used when you don't explicitly state which nodes should be saved in a simulation. Useful settings are "Save Device Currents", "Save Subcircuit Node Voltages", and "Save Subcircuit Device Currents". Device voltages and internal device voltages are only of internal program development use.

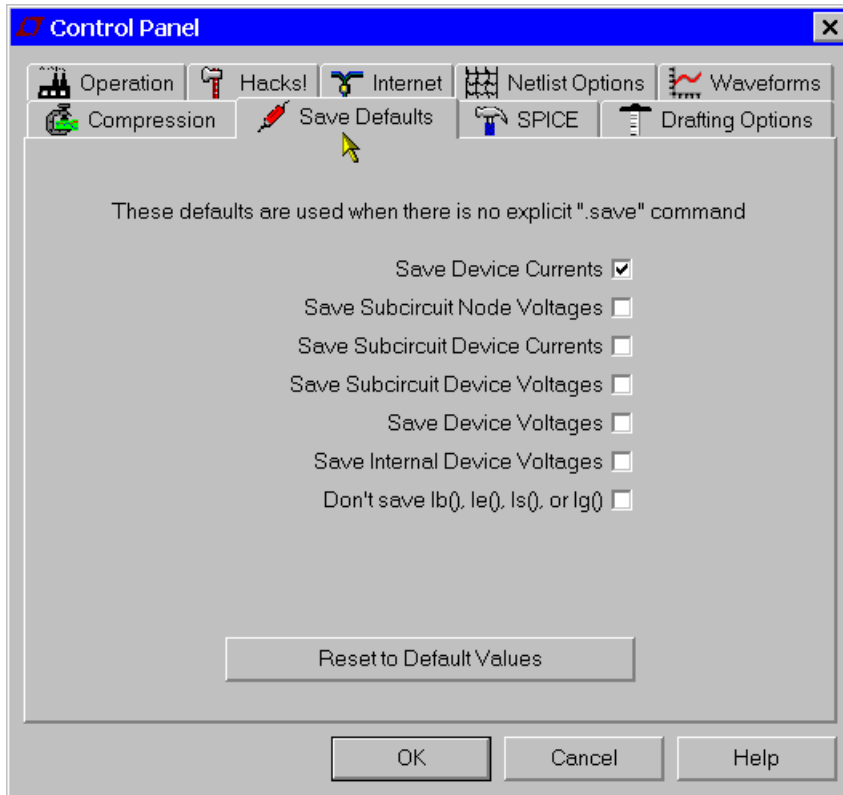

SPICE

This pane allows you to define the various defaults for LTspice. These defaults can be overridden in any simulation by specifying the options in that simulation. Usually you can leave these options as they are. If you have frequently updated the program over the web, you might want to press "Reset to Default Values" to reset to the current recommended settings.

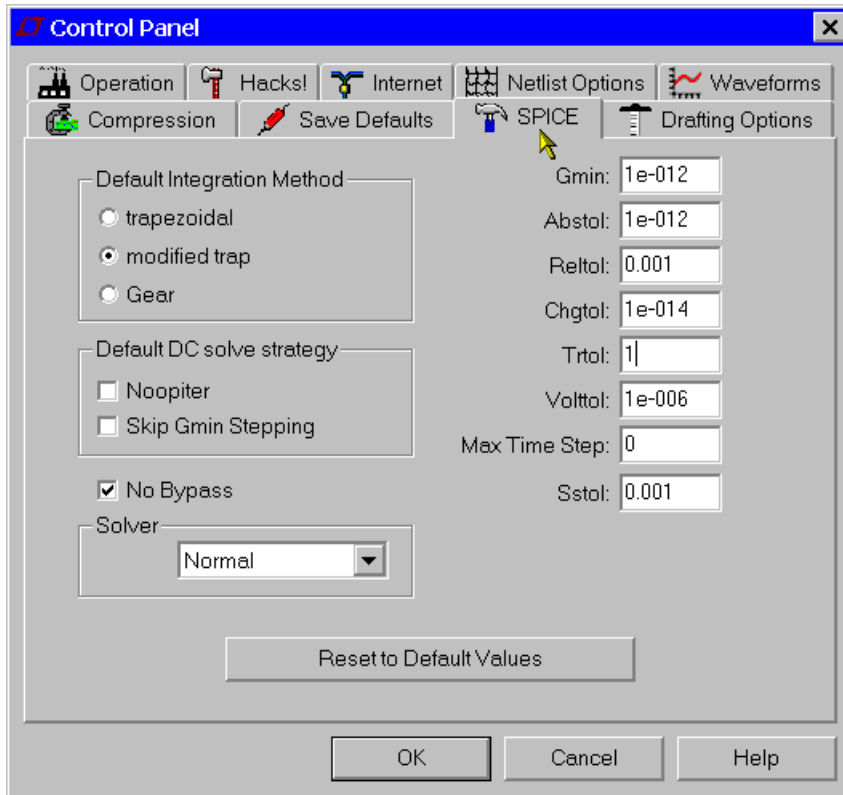

One default you may want to change is Trtol. Most commercial SPICE programs default this to 7. In LTspice this defaults to 1 so that simulations using the SMPS macro models are less likely to show any simulation artifacts in their waveforms. Trtol more affects the timestep strategy than directly affects the accuracy of the simulation. For transistor-level simulations, a value larger than 1 is usually a better overall solution. You might find that you get a speed of 2x if you increase trtol with out adversely affecting simulation accuracy.

Also interesting is which solver is used. LTspice contains two complete versions of SPICE. One is called the normal solver and the other is called the alternate solver. The alternate solver uses a different sparse matrix package with reduced roundoff error. Typically the alternate solver will simulate at half the speed of the normal solver but with one thousand times more internal accuracy. This can be a useful diagnostic to have available.

Netlist Options

Convert ' μ ' to 'u': Replace all instances of ' μ ' to 'u'. Useful if your MS Windows installation can't display a Greek Mu (as, e.g., some Chinese editions of Windows don't with default fonts) and (ii) generating netlists for SPICE simulators that don't understand the ' μ ' character as the metric multiplier of $1e-6$.

Convergence Aids: For Internal program development use only.

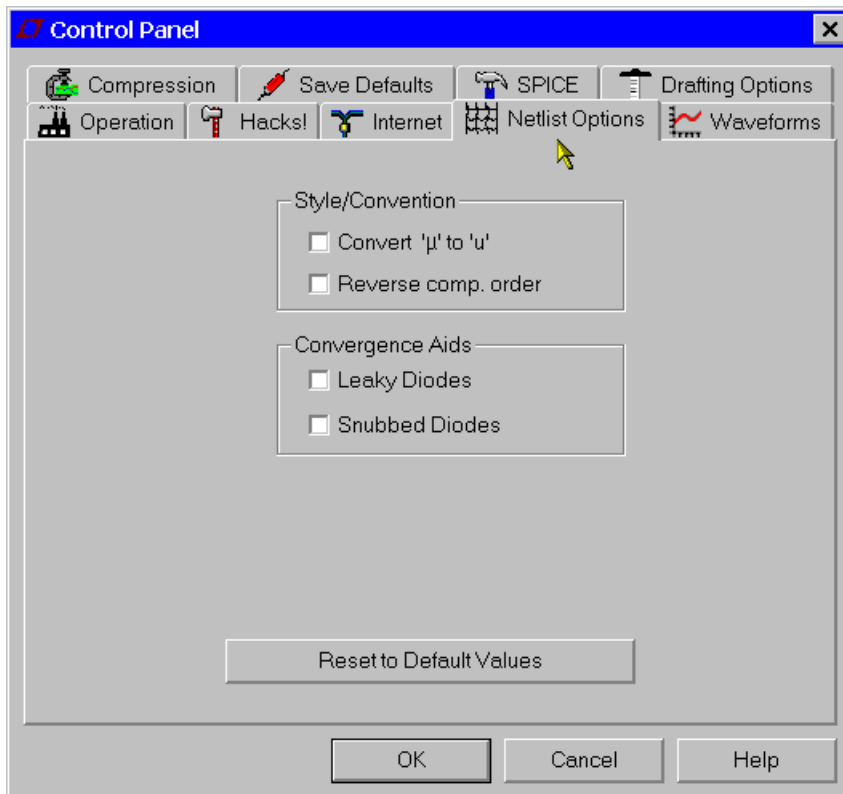

Hacks

This pane was used for internal program development, but is currently almost obsolete.

Usually you can leave these options as they are. If you have frequently updated the program over the web, you might want to press "Reset to Default Values" to reset to the current recommended settings.

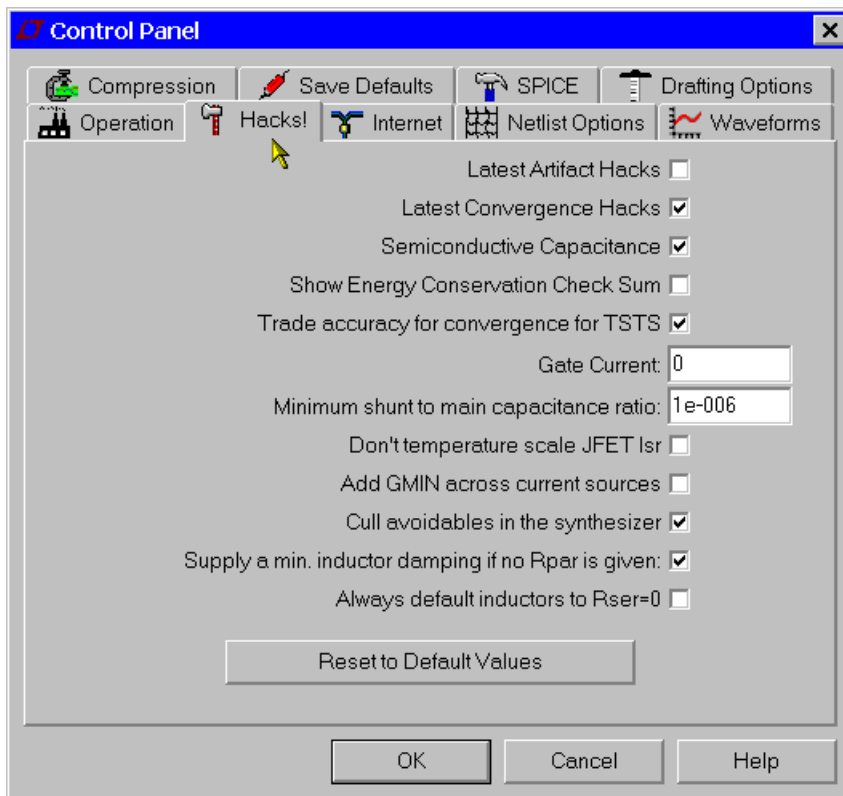

Drafting Options

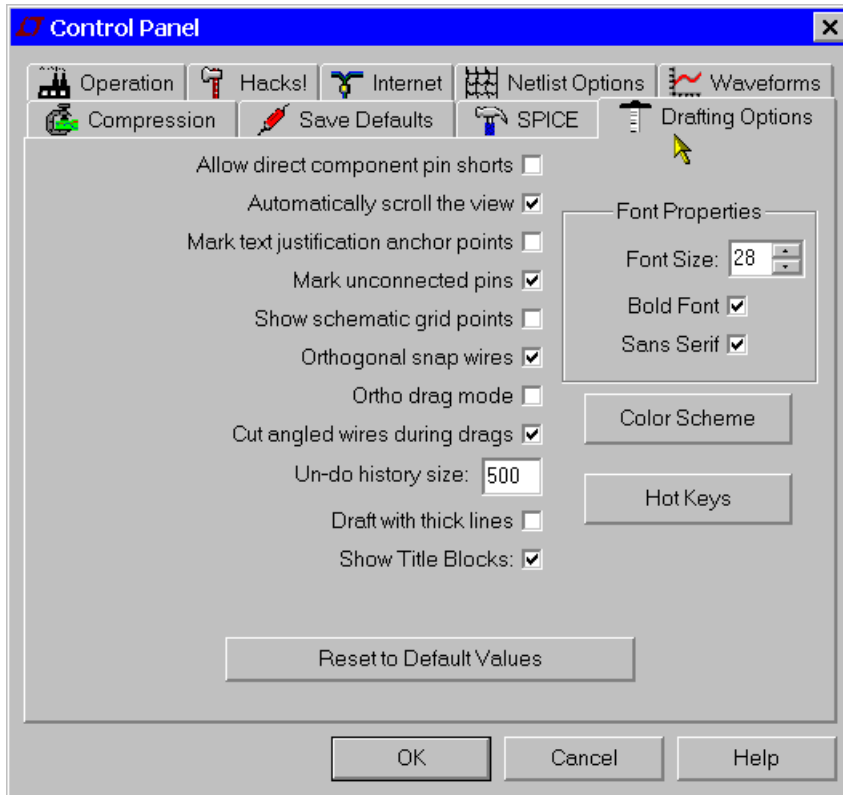

Allow direct component pin shorts: Normally you can draw a wire directly through a component and the wire segment shorting pins is deleted. If you check it, the shorting wire will not be automatically deleted.

Automatically scroll the view: Checking this box makes the view of the schematic scroll as you move the mouse close the edge while editing the schematic.

Mark text Justification anchor points: Draw a small circle to indicate the reference point of text blocks.

Mark unconnected pins: Draw a small square at each unconnected pin to flag it as unconnected.

Show schematic grid points: Start with visible grid enabled.

Orthogonal snap wires: Force wires to be drawn in vertical and horizontal segments while drawing. If not checked, a wire can be drawn at any angle and will snap to any grid. Holding down the control key will momentarily toggle the current setting while drawing wires.

Cut angled wires during drags: During the Drag command, a non-orthogonal wire will be broken into two connected wires if you click along the middle of the wire.

Undo history size: Set the size of the undo/redo buffer.

Draft with thick lines: Increases the all line widths. Useful for generating images for publication.

Show Title Block: For internal use.

Internet Option

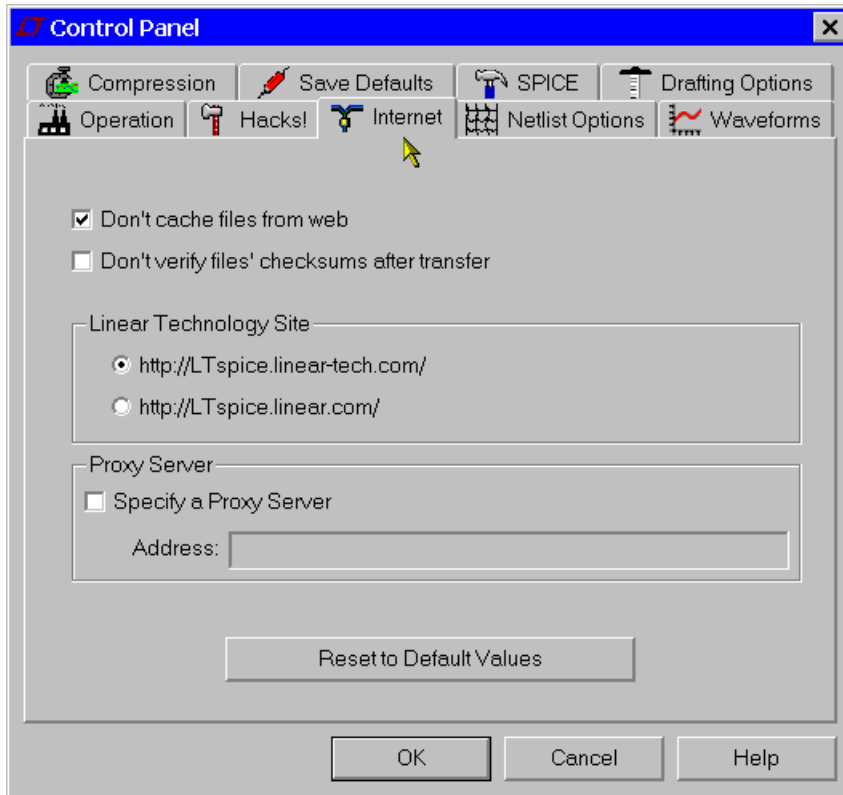

This pane of the Control Panel is used for the incremental updates obtained from the web. It should not be required to make any adjustments to these settings.

FAQs

Installation Problems

How do I install SwitcherCAD III?

1. Go to <http://www.linear.com/software> and download the file `swcadiii.exe` into a temporary directory on your PC.
2. Run the `swcadiii.exe` to install.

I'm running a Chinese Edition of Windows. The Greek Mu character doesn't show up correctly, what can I do?

That problem should be completely fixed in the current version of LTspice/SwCAD III. But you can go to the menu item Tools=>Control Panel=>Netlist Options and check "Convert ' μ ' to 'u'". This option now not only applies to netlists, but will draw a Greek Mu as 'u' wherever it might appear on the screen.

Program Updates

How do I get the latest version?

Once installed, there are two ways to getting the latest version. You can always reinstall the program again as mentioned in [Installation Problems](#). You don't have to remove the old version before installing. If your PC has an internet connection, it is much easier to get the latest release by using the [Sync_Release](#) feature.

How do I know what new features are added?

After you have updated your file to the latest version, the 'changelog.txt' file in your root directory, usually at c:\Program Files\ltc\swcadiii\Changelog.txt, has a detailed program revision list.

Can I go back to the old version after Sync_Release?

It is not reversible. All symbols, models, and programs are updated with the new ones. You need to make a backup copy before the Sync_Release starts. The component databases, standard.*, will be merged with the new ones automatically. If you added new inductors or capacitors, your devices will be preserved and merged with the new ones from program update. Your own local working file won't be affected.

Transformer Models

How do I build a transformer model?

The best way would be to draft a model with coupled inductors with a mutual inductance statement placed as a SPICE directive on the schematic. See the section in [mutual Inductance](#) for more information. Inductors participating in a mutual inductance will be drawn with a phasing dot.

The following example demonstrates a transformer with 1:3 turns ratio (one to nine inductance ratio) with a sine wave input and simulates for 0.1ms. The K is set to 1 to model a transformer with no leakage inductance.

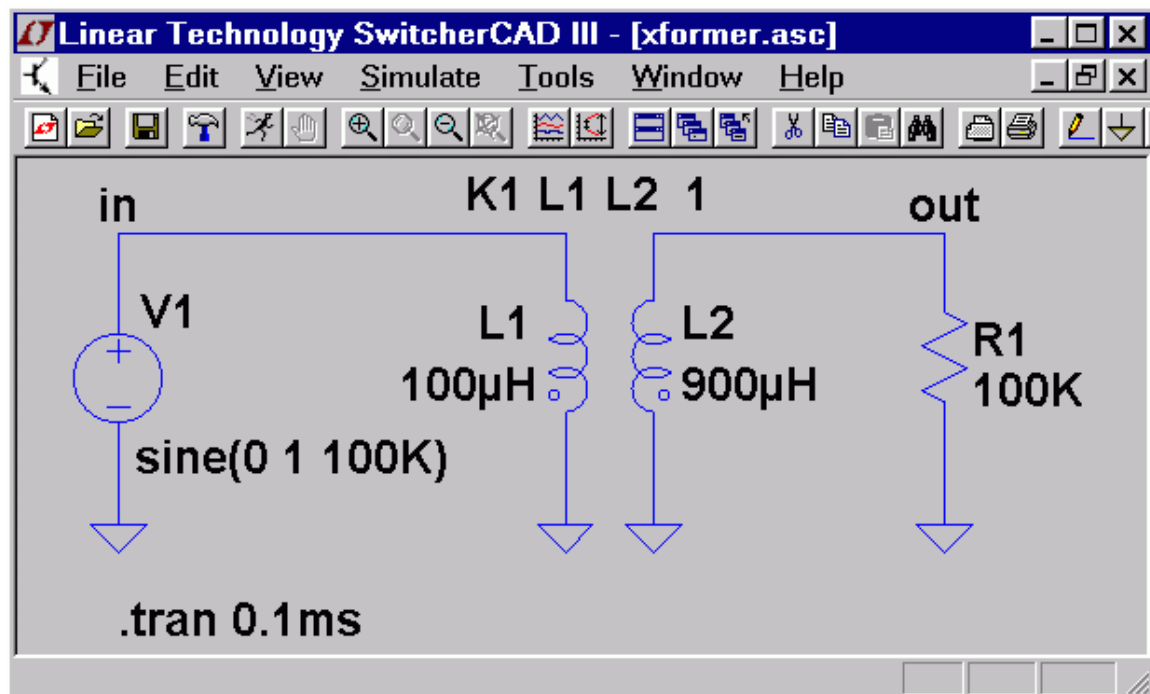

Third-party Models

This section explains how to add a third-party model in SwitcherCAD III.

The database files are all in the directory:

C:\Program Files\LTC\SwCADIII\lib\cmp

Capacitor: standard.cap

Inductor : standard.ind

Resistor : standard.res

The above three binary files must be opened with SwitcherCAD III 'File' 'Open' command and edited inside the dialog box.

Diode : standard.dio

BJT : standard.bjt

MOS : standard.mos

JFET : standard.jft

The above four files are ASCII text files and can be edited either with the SwitcherCAD III File=>Open command or any ASCII editor. All entries in these files must be defined with a .model statement, not as a subcircuit. If you want to use a subcircuit, follow the following steps:

1. Change the "Prefix" attribute of the component instance of the symbol to be an 'X'. Don't change the symbol, just the instances of the symbol as a component on a schematic.
2. Edit the value of the component to coincide with the name of the subcircuit you wish to use.
3. Add a SPICE directive on the schematic such as ".inc filename" where filename is the name of the file containing the definition of the subcircuit.

Inductor Models

How do I design a coupled inductor?

You first draw at least two inductors and then define the K coefficient between the two inductors.

See [mutual inductance](#) section.

How do I control the inductor parasitic resistance?

By default, LTspice will supply losses to inductors to aid SMPS transient analysis. For SMPS, these losses are of usually of no consequence, but may be turned off if desired. On the "Tools=> Control Panel=>Hacks!" page, uncheck "Supply a min. inductor damping if no Rpar is given" This setting will be remembered between invocations of the program. There is also a default series resistance of 1 milliOhm for inductors that aren't mentioned in a mutual inductance statement. This Rser allows SwitcherCAD III to integrate the inductance as a Norton equivalent circuit instead of Thevenin equivalent in order to reduce the size of the circuit's linearized matrix. If you don't want LTspice to introduce this minimum resistance, you must explicitly set Rser=0 for that inductor. This will require LTspice to use the more cumbersome Thevenin equivalent of the inductor during transient analysis.

Can I add/edit my own inductor model?

Open the file typically installed as

```
C:\Program Files\LTC\SwCADIII\lib\cmp\standard.ind
```

to add or edit inductor models.

MOSFET Models

What is the difference between SwitcherCAD III MOSFET and standard SPICE MOSFET models?

Besides the standard SPICE MOSFET models, SwitcherCAD III also includes a proprietary MOSFET model that is not implemented in other SPICE programs. It directly encapsulates the charge behavior of the vertical doubly diffused MOS transistor. This allows a power device to be modeled with an intrinsic VDMOS device LTspice instead of a subcircuit as in other SPICE programs. See [models](#) definition for details.

Can I add my own MOSFET models?

Yes, you can add your own model in the

C:\Program Files\LTC\SwCADIII\lib\cmp\standard.mos file. This file is only for devices defined with a .model statement, not as subcircuits. If you want to use a subcircuit, follow the following steps:

1. Change the "Prefix" attribute of the component instance of the symbol to be an 'X'. Don't change the symbol, just the instances of the symbol as a component on a schematic.
2. Edit the value of the component to coincide with the name of the subcircuit you wish to use.
3. Add a SPICE directive on the schematic such as ".inc filename" where filename is the name of the file containing the definition of the subcircuit.

License and Distribution

Can I re-distribute the software?

Yes, you can distribute the software freely whether you are a Linear Technology customer or not. See the [license](#) section for more details. Technical support for non-Linear Technology customers is purely discretionary.

Is it a shareware, freeware or demo?

This program is not a shareware or a demo. It is fully functional freeware. The purpose of this software is to help our customers use our products. It can also be used as a general-purpose circuit design package with schematic capture and SPICE simulation. We do encourage students using the program to become familiar with the analog design process. We cannot guarantee support for non Linear Technology related program usage, but we'll fix all general program bugs and appreciate such reports. We do extensive in-house testing and believe the program has superior convergence capability. There are no known outstanding bugs.

Who can I contact Linear Technology for help?

For all software issues e-mail scad3@linear.com.

For all hardware issues, such as additional application information for Linear Technology IC's, call Linear Technology application department at (408) 954-8400 during normal business hours.

Circuit Efficiency Calculation

What is the difference between *.APP and *.ASC files?

An APP file is a schematic file and has embedded control statements to help calculate efficiency and other product information. ASC file is the general schematic file without any hidden SPICE commands. ASC file is the more general and powerful file format. It is recommended that you save your own designs with a .ASC file name extension.

How can I get efficiency report for my schematic?

You need to add a ".TRAN <time> steady" statement on the schematic. The program will automatically detect the steady state by checking the internal state of the LTC macro-models. It doesn't work when LTC switching regulator part is absent. There must be exactly one Voltage source in the circuit. This will be identified as the input. There must be exactly one current source in the circuit. This will be identified as the load. After the simulation is done, you can select the 'Efficiency Report' under the 'View' menu to see the report on the schematic.

Custom Symbol

Can I create my own symbols?

Yes, you can create your own symbols.

How do I create my own symbol?

Start with the menu command File=>New Symbol.

Can I create my own switching regulator models?

Not very easily. The switching regulator models that ship with LTspice/SwitcherCAD III use new intrinsic SPICE devices designed to encapsulate the behavior of LTC's switching regulator products. Even if you succeed in making a model with standard SPICE primitives, the simulation time will be orders of magnitude longer. Note that some people have made such switching regulator models with standard SPICE devices. LTspice can run these models and will usually outperform the simulator for which they were targeted.

Memory Problems

How much memory do I need to run the program?

You should have enough memory to run Windows 95, 98, NT4.0, Me, or 2000. You can basically run the SwitcherCAD III if you can operate your Windows system. We have spent a great deal of effort in minimizing the memory requirement of this program. While a typical simulation might generate 8Gigabytes of raw data, that data will be compressed on the disk to 400Megabytes. To view a single trace would require less than 65Megabytes of RAM. Of course, the more memory the better the performance will be. Also, SwitcherCAD III benefits from the improved memory performance of Windows NT and 2000, so you might consider upgrading operating system if you run out of memory.

Where is the waveform stored during simulation?

All the waveform data are stored on hard disk. Only the plotted traces are loaded into RAM. Turning off the marching waveforms can reduce the RAM memory requirement. Note that for most analysis types, there is no particular file size limit. You can generate and view .raw files that are very many Gigabytes in size.

What if I don't have enough disk space for long simulation?

The waveform data has been compressed, but it is still proportional to the run time and the number of traces saved. The easiest way to save memory is to select desired traces for storing before the simulation starts.

OK, I've done everything and I'm still running out of memory. What can I do?

During a transient analysis, you can interactively throw away the past waveforms by pressing the '0' key. That will retrigger the simulation time to t=0 as the present time.

Model Compatibility

Is the new model compatible with the older one?

We are always improving the macromodels. Those changes usually produce more accurate device behavior and might not be noticeable by the user. For example, the quiescent and the pin-bias currents might be added but that doesn't appreciably change the transient waveforms. Occasionally, a symbol might be changed due to some special circumstance and that will affect schematics drafted with the former version of the symbol. Users are advised to keep a backup copy of the design and symbols used.

Are the switching regulator models compatible with Pspice models and others?

We used proprietary building blocks inside the switching regulator models to speed up the simulation and control the convergence. While it is possible, in principle, to translate the proprietary building blocks to standard SPICE equivalent blocks, the simulation will be hundreds of times

slower. Because of the performance concern, all switching regulators were built with proprietary blocks, and there is no translator, either. LTspice can, however, run Pspice semiconductor and behavioral models and is generally a much higher performance simulator, so you might move your Pspice simulations to LTspice.

SPICE Netlist

How do I create a SPICE netlist?

A netlist can be created with any text editor capable of generating an ASCII file. You can view the SPICE netlist of any schematic in SwitherCAD III with the command View=>SPICE netlist. From this view you can copy the netlist to the clipboard by selecting all text and typing Ctrl-C to bring the netlist to a different editor.

How do I run a netlist?

Just open the text file first and then run it. LTspice/SwitcherCAD III will recognize the file as a netlist if it has file extension of ".cir"

Exporting/Merging Waveform Data

Can I export the waveform data to other applications?

You can copy a plot as bitmap by making a waveform window the active window and typing Ctrl-C. Then, in an application that accepts bitmap pastes from the clipboard like Word or Paint, type Ctrl-V. Note that this also works for bitmaps of schematics.

OK, that works for bitmaps, but can I get the data itself to an application like Excel?

Not with the current version of LTspice/SwitcherCAD III. We plan on adding that capability in the future. However, there is a 3rd party free utility written by Helmut Sennewald of Herrenberg, Germany that will do that. It's available from the independent users' group <http://groups.yahoo.com/group/LTspice>. The utility allows various forms of manipulation of the data including the ability to merge waveforms from different simulation runs.

Runing under Linux

Do you have a Linux version of this program?

Not a separate edition, but it does run under WINE. The program has been tested on Linux RedHat 8.0 with WINE version 20030219.

OK, I've never used WINE, how do I install this?

1. Check with <http://www.winehq.com> to find the current version of WINE for your system. At the time of this writing, for RedHat 8.0, this points to <http://mecano.gme.usherb.ca/~vberon/wine>
2. Copy the appropriate .rpm file to your machine and open it from nautilus.
3. Get the file swcadiii.exe from <http://www.linear.com/software>. In an xterm, execute "wine swcadiii.exe" to install LTspice.
4. There will now be a Linear Technology Logo on your gnome desktop. Double click it to start or type "wine scad3.exe" from an xterm to start the program.

The schematic fonts don't scale as smoothly under WINE as Windows. Why is that?

WINE is doing the best it can with the fonts it finds. It will do better if you tell it how to find the files arial.ttf and cour.ttf from your Windows system.

The PWL additional point editor doesn't look right under WINE?

Try using the native Windows .dll from your Windows system. The command line to then invoke LTspice from WINE is wine -dll commctrl,comctl32=n scad3.exe.

It seems LTspice is running slightly differently under WINE/Linux than windows. Why is that?

LTspice detects whether or not it's running under WINE. If so, it works around a few WINE issues. You can force

LTspice to think it's running under WINE with the command line switch -wine. You can force it to think it's not with the command line switch -nowine in case you're interesting in working on WINE issues.

Appendixes

Symbols

Symbol Overview

This appendix documents the schematic symbols supplied with LTspice.

Power Products

Overview

All macromodels reflect typical performance at room temperature (27 °C). Worst-case models are not covered.

The synchronization capability is usually not modeled except for devices that use phase locked loops. The macro models will not fail if over-voltaged. The absolute maximum ratings specified in the data sheets must be obeyed. Those device failure modes are not modeled.

LT1308A

High Current, Micropower Single Cell, 600kHz DC/DC Converter

PARAMETER	CONDITIONS	Device	Sim.
		Typical	Model
<u>UNITS</u>			
Quiescent Current uA	Not Switching	140	140
	Switching	2.5	3.2
mA			
Feedback Voltage V		1.22	1.23
Switch Frequency kHz	Vin=1.2V	600	590
Max. Duty Cycle %		90	90
Switch Current Limit A	Duty Cycle=30%	3	3.3
Switch Vcesat mV	"Isw=2A, Vin=1.5V"	290	320
Min. Input Voltage V		0.92	1

Low battery detector function are not implemented for those two models. Shutdown pin current is not modeled.

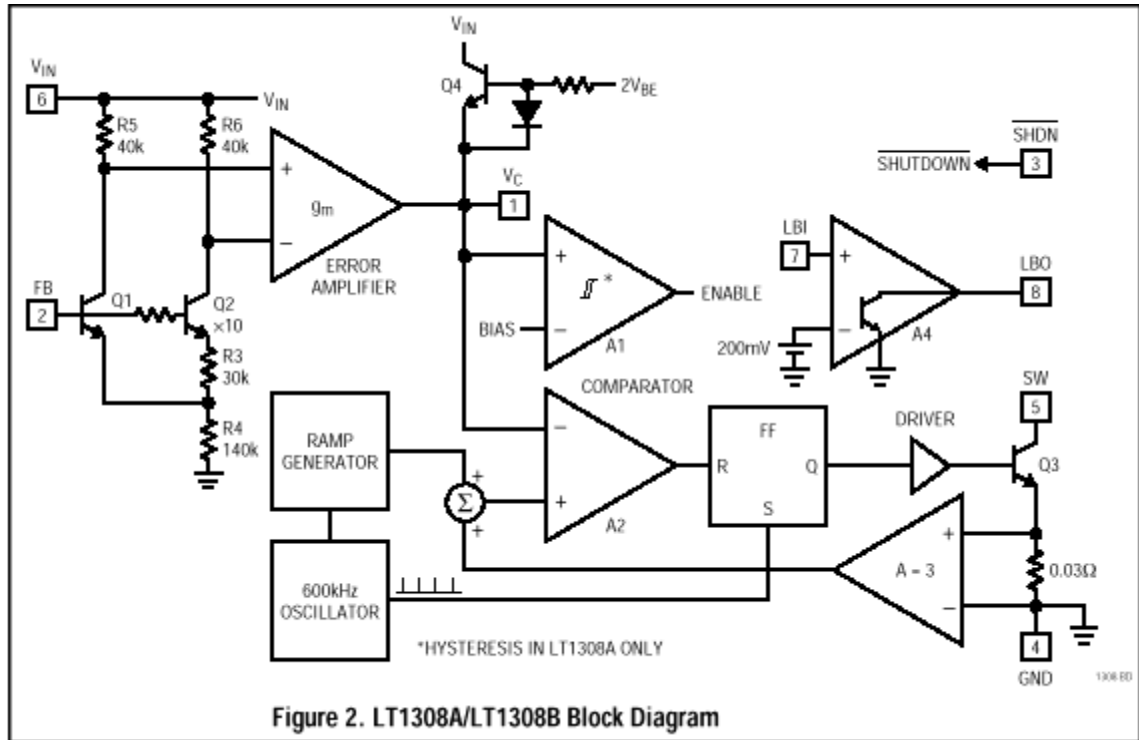

Demo-board DC207 LT1308 Vin=3.3V, Vout=5V

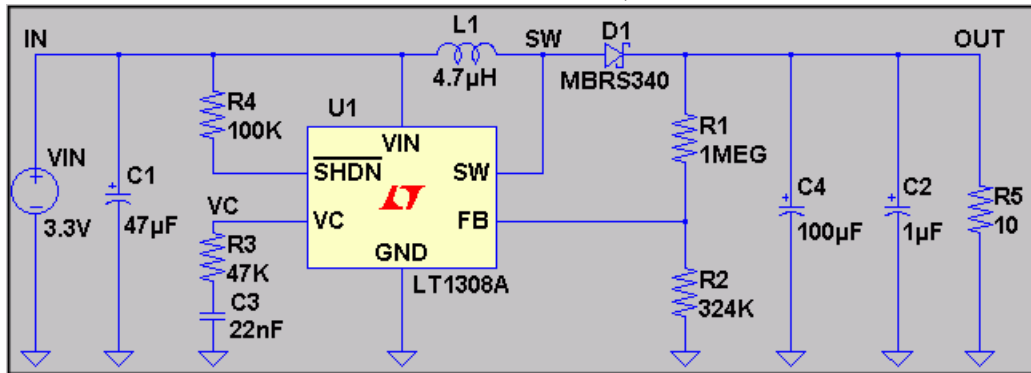

switching from 5% full load(25mA) to full load(500mA)

Step Load Response:

Simulation : PULSE(500M 25M 5M 0.1u 0.1u 5M 10M)

Measurement: Tek TDS 640A Scope, 100mV, 2.5mS

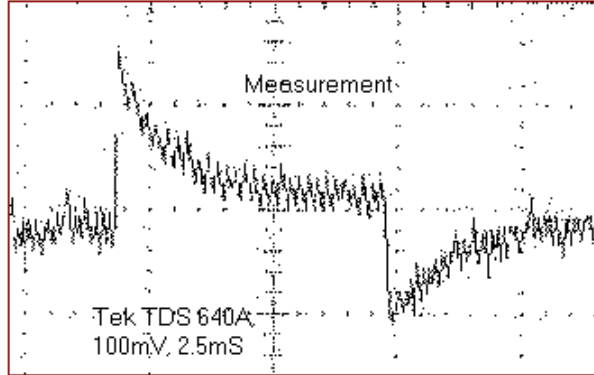
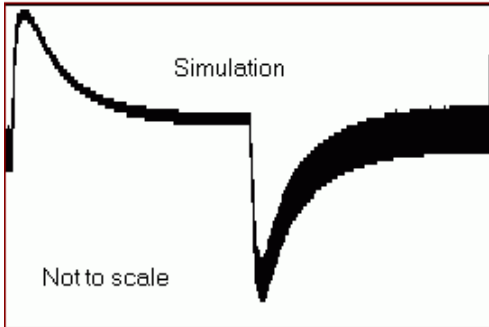

Startup Response:

Simulation : $V_{in}=3.3V$, $V_{out}=5V$, $I_{load}=500mA$.

Measurement: Tek TDS 640A Scope, 2.00V, 500uS

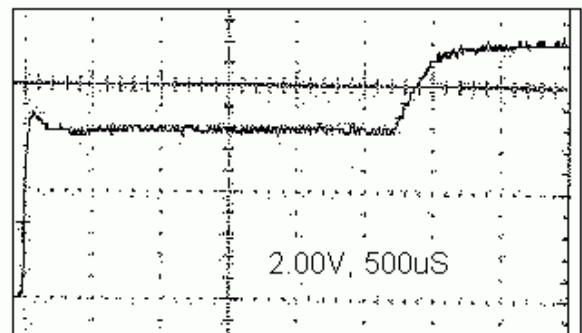
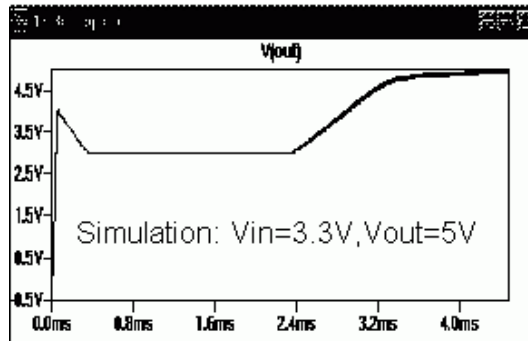

LTC1435A

SFB bias current not implemented. Gate drivers' transition time is not guaranteed at 50ns. Reference voltage line and load regulations are not characterized. Shutdown supply current is not a function of input voltage.

LTC1735

Gate drive rise and fall time are not characterized. Supply current consumption between operation modes are not implemented. Reference line and load regulation are not implemented. In the model, RUN/SS capacitor can't not be used as a short-circuit time-out circuit.

LTC1628

High Efficiency, 2-Phase Synchronous Step-Down Switching Regulator

When FCB is above 4.8V, Burst mode is not disabled. Gate drive rise and fall time are not characterized. Supply current consumption between operation modes are not implemented. Reference line and load regulation are not implemented. Device turn on LDO independent of soft-start when pin STBYMD is set to above 2V, however the model set LDO to be independent of soft-start regardless of the voltage on STBYMD pin

LTC1624

Gate drive rise and fall time are not characterized. Supply current consumption between operation modes are not implemented. Reference line and load regulation are not implemented.

LTC1622

Low Input Voltage Current Mode Step-Down DC/DC Controller

Gate drive rise and fall times are not characterized. Supply current consumption between operation modes is not implemented. Undervoltage lockout hysteresis is not implemented.

LT1026

Switched Capacitor Voltage Converter

LT1054

Switched-Capacitor Voltage Converter with Regulator

LT1054L

Switched-Capacitor Voltage Converter with Regulator

LT1070

5A High Efficiency Switching Regulator

LT1070HV

5A High Efficiency Switching Regulator (High Voltage version)

LT1071

2.5A High Efficiency Switching Regulator

LT1071HV

2.5A High Efficiency Switching Regulator (High Voltage version)

LT1072

1.25A High Efficiency Switching Regulator

LT1072HV

1.25A High Efficiency Switching Regulator (High Voltage version)

LT1073

5 Volt Micropower DC/DC Converter

LT1073-5

5 Volt Micropower DC/DC Converter

LT1073-12

12 Volt Micropower DC/DC Converter

LT1074

5A Step-Down Switching Regulator

LT1074HV

5A Step-Down Switching Regulator

LT1076

2A Step-Down Switching Regulator

LT1082

1A High Voltage, Efficiency Switching Voltage Regulator

LT1084

5A Low Dropout Positive Adjustable Regulator

LT1085

5A Low Dropout Positive Adjustable Regulator

LT1103

Offline Switching Regulator

LT1105

Offline Switching Regulator

LT1106

Micropower Step-Up DC/DC Converter for PCMCIA Card Flash Memory

LT1107

Adjustable Micropower DC/DC Converter

LT1107-5

5 Volt Micropower DC/DC Converter

LT1107-12

12 Volt Micropower DC/DC Converter

LT1108

Adjustable Micropower DC/DC Converter

LT1108-12

12Volt Micropower DC/DC Converter

LT1109

Micropower Low Cost DC/DC Converter Adjustable

LT1109-12

Micropower Low Cost DC/DC Converter Fixed 12V

LT1109-5

Micropower Low Cost DC/DC Converter Fixed 5V

LT1110-5

5 Volt Micropower DC/DC Converter

LT1110-12

12 Volt Micropower DC/DC Converter

LT1111

Adjustable Micropower DC/DC Converter

LT1111-5

5 Volt Micropower DC/DC Converter

LT1170

100kHz, 5A High Efficiency Switching Regulator

LT1170HV

100kHz, 5A High Efficiency Switching Regulators Vin: 3V to 60V

LT1171

100kHz, 2.5A High Efficiency Switching Regulator

LT1171HV

100kHz, 2.5A High Efficiency Switching Regulators Vin: 3V
to 60V

LT1172

100kHz, 1.25A High Efficiency Switching Regulators

LT1172HV

100kHz, 1.25A High Efficiency Switching Regulators Vin: 3V
to 60V

LT1173

Adjustable Micropower DC/DC Converter

LT1173-5

5 Volt Micropower DC/DC Converter

LT1173-12

12 Volt Micropower DC/DC Converter

LT1176

Step-Down Switching Regulator, Adjustable Output
Voltage

LT1176-5

Step-Down Switching Regulator, Fixed 5V Output

LT1182

CCFL/LCD Contrast Switching Regulator

LT1183

CCFL/LCD Contrast Switching Regulator

LT1184

CCFL Switching Regulator, Grounded-Lamp

LT1184F

CCFL Switching Regulator, Floating-Lamp or Grounded-Lamp

LT1186F

DAC Programmable CCFL Switching Regulator (Bits-to-Nits(TM))

LT1242

High Speed Current Mode Pulse Width Modulator

LT1243

High Speed Current Mode Pulse Width Modulator

LT1245

High Speed Current Mode Pulse Width Modulator

LT1246

1MHz Off-Line Current Mode PWM and DC/DC Converter

LT1247

1MHz Off-Line Current Mode PWM and DC/DC Converter

LT1248

Power Factor Controller(NOTE External sync capability is not modeled)

LT1249

Power Factor Controller(NOTE External sync capability is not modeled)

LT1269

4A High Efficiency Switching Regulator

The model's performance in flyback configuration is not verified.

LT1268

7.5A 150kHz Switching Regulator

The model's performance in flyback configuration is not verified.

LT1268B

7.5A 150kHz Switching Regulator

LT1270

8A High Efficiency Switching Regulator

LT1270A

10A High Efficiency Switching Regulator

LT1271

4A High Efficiency Switching Regulator

LT1300

Micropower High Efficiency 3.3/5V Step-Up DC/DC Converter

LT1301

Micropower High Efficiency 5V/12V Step-Up DC/DC Converter for Flash Memory

LT1302

Micropower High Output Current Step-Up Adjustable DC/DC Converter

LT1302-5

Micropower High Output Current Step-Up Fixed 5V DC/DC Converter

LT1303

Micropower High Efficiency DC/DC Converters with Low-Battery Detector Adjustable

LT1303-5

Micropower High Efficiency DC/DC Converters with Low-Battery Detector, Fixed 5V

LT1304

Micropower DC/DC Converters with Low-Battery Detector Active in Shutdown

LT1304-3.3

Micropower DC/DC Converters with Low-Battery Detector Active in Shutdown

LT1304-5

Micropower DC/DC Converters with Low-Battery Detector Active in Shutdown

LT1305

Micropower High Power DC/DC Converter with Low-Battery Detector

Shutdown pin bias current is not modeled, because the input voltage level is the trigger, not current. The low battery input sensor's input bias current and output leakage current are also not modeled for the same reason. Mostly the output is fed into a logic input, which is high impedance. Currents for those pins are in the nA range.

LT1306

Synchronous, Fixed Frequency Step-Up DC/DC Converter

LT1307

Single Cell Micropower 600kHz PWM DC/DC Converters

LT1307B

Single Cell Micropower 600kHz PWM DC/DC Converters

LT1309

500kHz Micropower DC/DC Converter for Flash Memory

Shutdown bias current is not modeled. Soft-start start-up waveforms can't fully match the data sheet's waveforms.

LT1316

Micropower DC/DC Converter with Programmable Peak Current Limit

LT1317

Micropower, 600kHz PWM DC/DC Converters

LT1317B

Micropower, 600kHz PWM DC/DC Converters, Continuous Switching at Light Loads (LT1317B)

LT1336

Half-Bridge N-Channel Power MOSFET Driver with Boost Regulator

LT1370

500kHz High Efficiency 6A Switching Regulator

LT1371

500kHz High Efficiency 3A Switching Regulator

LT1371HV

500kHz High Efficiency 3A Switching Regulator (High Voltage version)

LT1372

1.5A, 500kHz High Efficiency Step-Down Switching Regulator, Adjustable Output Voltage

The soft-start pin for the LT1372/LT1377 can be used to synchronize with an external oscillator, but the model does not have this capability, It is disabled for now. Also not modeled is the input current to the soft-start pin as a function of voltage.

LT1372HV

1.5A, 500kHz High Efficiency Step-Down Switching Regulator, Adjustable Output Voltage (High Voltage version)

LT1373

250kHz Low Supply Current High Efficiency 1.5A Switching Regulator, Adjustable Output Voltage

LT1373HV

250kHz Low Supply Current High Efficiency 1.5A Switching Regulator, Adjustable Output Voltage

LT1374

4.5A, 500KHz Step-Down Switching Regulator

LT1374-5

4.5A, 500KHz Step-Down Switching Regulator, Fixed 5Volt Output

LT1375

1.5A, 500kHz Step-Down Switching Regulators

The synchronization pin is not modeled.

LT1375HV

1.5A, 500kHz Step-Down Switching Regulator, Adjustable Output Voltage

LT1375-5

1.5A, 500kHz Step-Down Switching Regulator

LT1376

1.5A, 500kHz Step-Down Switching Regulators

LT1376HV

1.5A, 500kHz Step-Down Switching Regulator, Adjustable Output Voltage

LT1376-5

1.5A, 500kHz Step-Down Switching Regulator, Fixed 5V Output

LT1377

500kHz and 1MHz High Efficiency 1.5A Switching Regulators

The soft-start pin for the LT1372/LT1377 can be used to synchronize with an external oscillator, but the model does not have this capability. Also not modeled is the input current to the soft-start pin as a function of voltage.

LT1339

High Power Synchronous DC/DC Controller

LT1424-5

Isolated Flyback Switching Regulator with 5V Output

LT1424-9

Isolated Flyback Switching Regulator with 9V Output

LT1425

Isolated Flyback Switching Regulator

LT1432

5V High Efficiency Step-Down Switching Regulator Controller

LT1432-3.3

3.3V High Efficiency Step-Down Switching Regulator Controller

LT1500

Adaptive-Frequency Current-Mode Switching Regulator, Adjustable Output Voltage

LT1501

Adaptive-Frequency Current-Mode Switching Regulator, Adjustable Output Voltage

LT1501-3.3

Adaptive-Frequency Current-Mode Switching Regulator, Fixed 3.3V Output

LT1501-5

Adaptive-Frequency Current-Mode Switching Regulator, Fixed 5V Output

LT1505

Constant-Current/Voltage High Efficiency Battery Charger

LT1505-1

Constant-Current/Voltage High Efficiency Battery
Charger

LT1506

4.5A, 500KHz Step-Down Switching Regulator, Adjustable
Output Voltage

Shutdown pin bias current is not accurately modeled.

LT1506-3.3

4.5A, 500KHz Step-Down Switching Regulator, Fixed 3.3V
Output

LT1500-3

Adaptive-Frequency Current-Mode Switching Regulator,
Selectable 3.3V or 5V Output

LT1507

500kHz Monolithic Buck Mode Switching Regulator,
Adjustable Output Voltage

Shutdown pin bias current is not accurately modeled.

LT1507-3.3

500kHz Monolithic Buck Mode Switching Regulator, Fixed
3.3V Output Voltage

LT1508

Power Factor and PWM Controller (Voltage Mode)

LT1509

Power Factor and PWM Controller

LT1510-5

500KHz Constant-Voltage/Constant-Current Battery
Charger

LT1510

Constant-Voltage/Constant-Current Battery Charger

LT1512

SEPIC Constant-Current/Constant Voltage Battery Charger

LT1529

3A Low Dropout Regulator with Micropower Quiescent Current and Shutdown

LT1533

Ultralow Noise 1A Switching Regulator

LT1534

Ultralow Noise 2A Switching Regulator

LT1572

100kHz, 1.25A High Efficiency Switching Regulator with Catch Diode

LT1576

1.5A, 200kHz Step-Down Switching Regulator, Adjustable Output Voltage

LT1578

1.5A, 200kHz Step-Down Switching Regulator, Adjustable Output Voltage

LT1576-5

1.5A, 200kHz Step-Down Switching Regulator, Fixed 5V Output

LT1612

Synchronous, Step-Down 800KHz PWM DC/DC Converter

LT1613

1.4MHz, Single Cell DC/DC Converter in 5-Lead SOT-23
Shutdown pin bias current and hysteresis are not implemented.

LT1614

Inverting 600kHz Switching Regulator

LT1615

Shutdown pin bias current and hysteresis are not implemented.

LT1617

Shutdown pin bias current and hysteresis are not implemented.

LT1618

Constant-Current/Constant-Voltage 1.4MHz Step-Up DC/DC Converter

LT1610

1.7MHz, Single Cell Micropower DC/DC Converter

LT1611

Inverting 1.4MHz Switching Regulator in 5-Lead SOT-23

LT1615-1

Micropower Step-Up DC/DC Converter in SOT-23

LT1616

600m5A, 1.4MHz Step-Down Switching Regulator in SOT-23

LT1617

Micropower Inverting DC/DC Converters in SOT-23

LT1617-1

Micropower Inverting DC/DC Converters in SOT-23

LT1619

Low Voltage Current Mode PWM Controller

LT1620

Rail-to-Rail Current Sense Amplifier

LT1620S8

Rail-to-Rail Current Sense Amplifier

LT1621

Dual Rail-to-Rail Current Sense Amplifier

LT1676

Wide Input Range, High Efficiency, Step-Down Switching Regulator

LT1680

High Power DC/DC Step-Up Controller

LT1725

General Purpose Isolated Flyback Controller

LT1735

High Efficiency Synchronous Step-Down Switching Regulator

LT1737

High Power Isolated Flyback Controller

LT1761-1.8

100mA Low Noise Low Dropout Micropower Regulator with Shutdown in SOT-23, 1.8V Output

LT1761-2.5

100mA Low Noise Low Dropout Micropower Regulator with Shutdown in SOT-23, 2.5V Output

LT1761-3

100mA Low Noise Low Dropout Micropower Regulator with Shutdown in SOT-23, 3V Output

LT1761-5

100mA Low Noise Low Dropout Micropower Regulator with Shutdown in SOT-23, 5V Output

LT1761-BYP

100mA Low Noise Low Dropout Micropower Regulator in SOT-23, Adjustable Output Voltage

LT1761-SD

100mA Low Noise Low Dropout Micropower Regulator with Shutdown in SOT-23, Adjustable Output Voltage

LT1761-3.3

100mA Low Noise Low Dropout Micropower Regulator with Shutdown in SOT-23, 3.3V Output

LT1762

150mA Low Noise Low Dropout Micropower Regulator with Shutdown, Adjustable Output Voltage

LT1762-1.5

150mA Low Noise Low Dropout Micropower Regulator with Shutdown, 1.5V

LT1762-1.8

150mA Low Noise Low Dropout Micropower Regulator with Shutdown, 1.8V

LT1762-2.5

150mA Low Noise Low Dropout Micropower Regulator with Shutdown, 2.5V

LT1762-3.3

150mA Low Noise Low Dropout Micropower Regulator with Shutdown, 3.3V

LT1762-3

150mA Low Noise Low Dropout Micropower Regulator with Shutdown, 3V

LT1762-5

150mA Low Noise Low Dropout Micropower Regulator with Shutdown, 5V

LT1763

500mA Low Noise Low Dropout Micropower Regulator with Shutdown, Adjustable Output Voltage

LT1763-1.5

500mA Low Noise Low Dropout Micropower Regulator with Shutdown, 1.5V

LT1763-1.8

500mA Low Noise Low Dropout Micropower Regulator with Shutdown, 1.8V

LT1763-2.5

500mA Low Noise Low Dropout Micropower Regulator with Shutdown, 2.5V

LT1763-3.3

500mA Low Noise Low Dropout Micropower Regulator with Shutdown, 3.3V

LT1763-3

500mA Low Noise Low Dropout Micropower Regulator with Shutdown, 3V

LT1763-5

500mA Low Noise Low Dropout Micropower Regulator with Shutdown, 5V

LT1764

3A, Fast Transient Response, Low Noise, LDO Regulator, Adjustable Output Voltage

LT1764-1.5

3A, Fast Transient Response, Low Noise, LDO Regulator, 1.5V Output

LT1764-1.8

3A, Fast Transient Response, Low Noise, LDO Regulator, 1.8V Output

LT1764-2.5

3A, Fast Transient Response, Low Noise, LDO Regulator, 2.5V Output

LT1764-3.3

3A, Fast Transient Response, Low Noise, LDO Regulator, 3.3V Output

LT1767

Monolithic 1.5A, 1.25MHz Step-Down Switching Regulator

LT1776

Wide Input Range, High Efficiency, Step-Down Switching Regulator

LT1777

Low Noise Step-Down Switching Regulator

LT1786F

SMBus Programmable CCFL Switching Regulator (Bits-to-Nits(TM))

LT1930

1A 1.2Mhz boost DC/DC Converter in ThinSOT

LT1930A

1A, 2.2Mhz Boost DC/DC Converter in ThinSOT

LT1931

1.2Mhz Inverting DC/DC Converter in ThinSOT

LT1931A

2.2Mhz Inverting DC/DC Converter in ThinSOT

LT1949

600kHz, 1A Switch PWM DC/DC Converter

LT1956

High Voltage, 1.5A, 500KHz Step-Down Switching Regulator

LT1959

4.5A, 500KHz Step-Down Switching Regulator, Adjustable Output Voltage

LT1962

300mA Low Noise Low Dropout Micropower Regulator with Shutdown, Adjustable Output Voltage

LT1962-1.5

300mA Low Noise Low Dropout Micropower Regulator with Shutdown, 1.5V

LT1962-1.8

300mA Low Noise Low Dropout Micropower Regulator with Shutdown, 1.8V

LT1962-2.5

300mA Low Noise Low Dropout Micropower Regulator with Shutdown, 2.5V

LT1962-3

300mA Low Noise Low Dropout Micropower Regulator with Shutdown, 3V

LT1962-5

300mA Low Noise Low Dropout Micropower Regulator with Shutdown, 5V

LT1963

1.5A, Low Noise, Fast Transient Response LDO Regulator, Adjustable Output Voltage

LT1963-1.5

1.5A, Low Noise, Fast Transient Response LDO Regulator, 1.5V

LT1963-1.8

1.5A, Low Noise, Fast Transient Response LDO Regulator, 1.8V

LT1963-2.5

1.5A, Low Noise, Fast Transient Response LDO Regulator, 2.5V

LT1963-3.3

1.5A, Low Noise, Fast Transient Response LDO Regulator, 3.3V

LT1956-5

High Voltage, 1.5A, 500KHz Step-Down Switching Regulator, Fixed 5V Output

LTC660

100mA CMOS Voltage Converter

LTC1044

Switched Capacitor Voltage Converter

LTC1044A

12V CMOS Switched Capacitor Voltage Converter

LTC1046

"Inductorless" 5V to -5V Converter

LTC1142

Dual High Efficiency Synchronous Step-Down Switching Regulator Controller, Fixed 3.3V and 5V Outputs

LTC1142HV

Dual High Efficiency Synchronous Step-Down Switching Regulator Controller, Fixed 3.3V and 5V Outputs

LTC1142HV-ADJ

Dual High Efficiency Synchronous Step-Down Switching Regulator Controller, Adjustable Output Voltages

LTC1142L-ADJ

Dual High Efficiency Synchronous Step-Down Switching Regulator Controller, Adjustable Output Voltages

LTC1143

Dual High Efficiency SO-16 Step-Down Switching Regulator Controller, Fixed 3.3V and 5V Outputs

LTC1143L

Dual High Efficiency SO-16 Step-Down Switching Regulator Controller, Fixed 3.3V and 5V Outputs

LTC1143L-ADJ

Dual High Efficiency SO-16 Step-Down Switching Regulator Controller, Adjustable Output Voltages

LTC1144

Switched-Capacitor Wide Input Range Voltage Converter with Shutdown

LTC1147-3.3

High Efficiency Step-Down Switching Regulator Controller, Fixed 3.3V Output

LTC1148L

High Efficiency Synchronous Step-Down Switching Regulator Controller, Adjustable Output Voltage

LTC1148L-3.3

High Efficiency Synchronous Step-Down Switching Regulator Controller, Fixed 3.3V Output

LTC1149

High Efficiency Synchronous Step-Down Switching Regulator Controller, Adjustable Output Voltage

LTC1149-3.3

High Efficiency Synchronous Step-Down Switching Regulator Controller, Fixed 3.3V Output

LTC1149-5

High Efficiency Synchronous Step-Down Switching Regulator Controller, Fixed 5V Output

LTC1159

High Efficiency Synchronous Step-Down Switching Regulator Controller, Adjustable Output Voltage

LTC1159-3.3

High Efficiency Synchronous Step-Down Switching Regulator Controller, Fixed 3.3V Output

LTC1626

Low Voltage, High Efficiency Step-Down DC/DC Controller, Adjustable Output Voltage

LTC1159-5

High Efficiency Synchronous Step-Down Switching Regulator Controller, Fixed 5V Output

LTC1174

High Efficiency Step-Down and Inverting DC/DC Converter

LTC1174-3.3

High Efficiency Step-Down and Inverting DC/DC Converter

LTC1174-5

High Efficiency Step-Down and Inverting DC/DC Converter

LTC1174HV

High Efficiency Step-Down and Inverting DC/DC Converter

LTC1174HV-3.3

High Efficiency Step-Down and Inverting DC/DC Converter

LTC1174HV-5

High Efficiency Step-Down and Inverting DC/DC Converter

LTC1261

Switched Capacitor Regulated Voltage Inverter

LTC1261CS8

Switched Capacitor Regulated Voltage Inverter

LTC1261LCS8

Switched Capacitor Regulated Voltage Inverter

LTC1261LCS8-4

Switched Capacitor Regulated Voltage Inverter, Fixed
4V Output

LTC1261LCS8-4.5

Switched Capacitor Regulated Voltage Inverter, Fixed
4.5V Output

LTC1262

12V, 30mA Flash Memory Programming Supply

LTC1263

12V, 60mA Flash Memory Programming Supply

LTC1265

1.2A, High Efficiency Step-Down DC/DC Controller,
Adjustable Output Voltage

LTC1265-3.3

1.2A, High Efficiency Step-Down DC/DC Controller,
Fixed 3.3V Output

LTC1265-5

1.2A, High Efficiency Step-Down DC/DC Controller,
Fixed 5V Output

LTC1266

Synchronous Regulator Controller for N- or P-Channel
MOSFETs, Adjustable Output Voltage

LTC1266-3.3

Synchronous Regulator Controller for N- or P-Channel
MOSFETs, Fixed 3.3V Output

LTC1266-5

Synchronous Regulator Controller for N- or P-Channel
MOSFETs, Fixed 5V Output

LTC1267

Dual High Efficiency Synchronous Step-Down Switching
Regulator Controller, Fixed 3.3V and 5V Outputs

LTC1267-ADJ

Dual High Efficiency Synchronous Step-Down Switching
Regulator Controller, Adjustable Output Voltages

LTC1267-ADJ5

Dual High Efficiency Synchronous Step-Down Switching Regulator Controller, One Adjustable Output Voltage and One Fixed 5V Output

LTC1430

High Power Step-Down Synchronous Switching Regulator Controller

LTC1430A

High Power Step-Down Synchronous Switching Regulator Controller

LTC1433

450mA, Low Noise Current Mode Step-Down DC/DC Converter

LTC1434

450mA, Low Noise Current Mode Step-Down DC/DC Converter

LTC1436A

High Efficiency Low Noise Synchronous Step-Down Switching Regulator

LTC1436A-PLL

High Efficiency Low Noise Synchronous Step-Down Switching Regulator

LTC1437A

High Efficiency Low Noise Synchronous Step-Down Switching Regulator

LTC1438-ADJ

Dual High Efficiency, Low Noise, Synchronous Step-Down Switching Regulator

LTC1438

Dual High Efficiency, Low Noise, Synchronous Step-Down Switching Regulator

LTC1439

Dual High Efficiency, Low Noise, Synchronous Step-Down Switching Regulator

LTC1474

Low Quiescent Current, High Efficiency Step-Down Converter, Adjustable Output Voltage

LTC1475

Low Quiescent Current, High Efficiency Step-Down Converter, Adjustable Output Voltage

LTC1475-5

Low Quiescent Current, High Efficiency Step-Down Converter, 5V Output

LTC1502-3.3

Single Cell to 3.3V Regulated Charge Pump DC/DC Converter

LTC1503-1.8

High Efficiency Inductorless Step-Down DC/DC Converter, Fixed 1.8V Output

LTC1503-2

High Efficiency Inductorless Step-Down DC/DC Converter, Fixed 2V Output

LTC1504

500mA Low Voltage Step-Down Synchronous Regulator, Adjustable Output Voltage

LTC1504-3.3A

500mA Low Voltage Step-Down Synchronous Regulator, Fixed 3.3V Output

LTC1504A

500mA Low Voltage Step-Down Synchronous Regulator, Adjustable Output Voltage

LTC1504-3.3

500mA Low Voltage Step-Down Synchronous Regulator,
Fixed 3.3V Output

LTC1514-3.3

Step-Up/Step-Down Switched Capacitor DC/DC Converter
with Low-Battery Comparator, Fixed 3.3V Output

LTC1514-5

Step-Up/Step-Down Switched Capacitor DC/DC Converter
with Low-Battery Comparator, Fixed 5V Output

LTC1515

Step-Up/Step-Down Switched Capacitor DC/DC Converter
with Reset, Adjustable Output Voltage

LTC1515-3.3/5

Step-Up/Step-Down Switched Capacitor DC/DC Converter
with Reset, Programmable 3.3V or 5V Output Voltage

LTC1515-3/5

Step-Up/Step-Down Switched Capacitor DC/DC Converter
with Reset, Programmable 3V or 5V Output Voltage

LTC1516

Micropower Regulated 5V Charge Pump DC/DC Converter

LTC1517-3.3

Micropower Regulated 3.3V Charge Pump in a 5-Pin SOT-
23 Package

LTC1517-5

Micropower Regulated 5V Charge Pump in a 5-Pin SOT-23
Package

LTC1522

Micropower Regulated 5V Charge Pump DC/DC Converter

LTC1530

High Power Synchronous Switching Regulator Controller,
Adjustable Output Voltage

LTC1530-1.9

High Power Synchronous Switching Regulator Controller,
Fixed 1.9 Volt Output

LTC1530-2.5

High Power Synchronous Switching Regulator Controller,
Fixed 2.5 Volt Output

LTC1530-3.3

High Power Synchronous Switching Regulator Controller,
Fixed 3.3 Volt Output

LTC1530-2.8

High Power Synchronous Switching Regulator Controller,
Fixed 2.8 Volt Output

LTC1538-AUX

Dual High Efficiency, Low Noise, Synchronous Step-Down
Switching Regulator

LTC1539

Dual High Efficiency, Low Noise, Synchronous Step-Down
Switching Regulator

LTC1550

Low Noise, Switched Capacitor Regulated Voltage
Inverter, Adjustable Output

LTC1550L

Low Noise, Switched Capacitor Regulated Voltage
Inverter, Adjustable Output

LTC1550LCS8

Low Noise, Switched Capacitor Regulated Voltage
Inverter, Adjustable Output Voltage

LTC1550LCS8-2

Low Noise, Switched Capacitor Regulated Voltage
Inverter, Fixed 2V Output

LTC1550LCS8-2.5

Low Noise, Switched Capacitor Regulated Voltage
Inverter, Fixed 2.5V Output

LTC1550LCS8-4.1

Low Noise, Switched Capacitor Regulated Voltage
Inverter, Fixed 4.1V Output

LTC1550CS8-4.1

Low Noise, Switched Capacitor Regulated Voltage
Inverter, Fixed -4.1V Output

LTC1553

5-Bit Programmable Synchronous Switching Regulator
Controller for Pentium II Processor

LTC1553L

5-Bit Programmable Synchronous Switching Regulator
Controller for Pentium II Processor

LTC1574

High Efficiency Step-Down DC/DC Converter with
Internal Schottky Diode, Adjustable Output Voltage

LTC1574-3.3

High Efficiency Step-Down DC/DC Converter with
Internal Schottky Diode, Fixed 3.3V Output

LTC1574-5

High Efficiency Step-Down DC/DC Converter with
Internal Schottky Diode, Fixed 5V Output

LTC1625

No R_SENSE Current Mode Synchronous Step-Down Switching
Regulator

LTC1625-5

Low Voltage, High Efficiency Step-Down DC/DC Controller, Fixed 5V Output

LTC1626-3.3

Low Voltage, High Efficiency Step-Down DC/DC Controller, Fixed 3.3V Output

LTC1627

Monolithic Synchronous Step-Down Switching Regulator

LTC1628-PG

High Efficiency, 2-Phase Synchronous Step-Down Switching Regulator

LTC1629

PolyPhase, High Efficiency, Synchronous Step-Down Switching Regulator

LTC1629-PG

PolyPhase, High Efficiency, Synchronous Step-Down Switching Regulator

LTC1649

3.3V Input High Power Step-Down Synchronous Switching Regulator Controller, Adjustable Output Voltage

LTC1682

Doubler Charge Pump with Low Noise Linear Regulator, Adjustable Output Voltage

LTC1682-3.3

Doubler Charge Pump with Low Noise Linear Regular, Fixed 3.3V Output

LTC1682-5

Doubler Charge Pump with Low Noise Linear Regular, Fixed 5V Output

LTC1693-1

Dual High Speed MOSFET Driver

LTC1693-2

Dual High Speed MOSFET Driver

LTC1693-3

High Speed MOSFET Driver

LTC1701

1MHz Step-Down DC/DC Converter in SOT-23

LTC1701B

1MHz Step-Down DC/DC Converter in SOT-23

LTC1702

Dual 550kHz Synchronous 2-Phase Switching Regulator Controller NOTE Only one phase of two phases modeled

LTC1703

Dual 550kHz Synchronous 2-Phase Switching Regulator Controller with VID

LTC1706-19

VID Voltage Programmer

LTC1707

High Efficiency Monolithic Synchronous Step-Down Regulator (Note External sync. capability is not modeled)

LTC1709

2-Phase, 5-Bit Adjustable, High Efficiency, Synchronous Step-Down Switching Regulator

LTC1735-1

High Efficiency Synchronous Step-Down Switching Regulator

LTC1736

5-Bit Adjustable High Efficiency Synchronous Step-Down Switching Regulator

LTC1753

5-Bit Programmable Synchronous Switching Regulator Controller for Pentium II Processor

LTC1754-5

Micropower Regulated 5V Charge Pump with Shutdown in SOT-23

LTC1771

10 μ A Quiescent Current High Efficiency Step-Down DC/DC Controller

LTC1772B

Constant Frequency Current Mode Step-Down DC/DC Controller in SOT-23

LTC1772

Constant Frequency Current Mode Step-Down DC/DC Controller in SOT-23

LTC1773

Synchronous Step-Down Regulator Controller

LTC1775

High Power No Rsense(TM) Current Mode Synchronous Step-Down Switching Regulator

LTC1778

Wide Operating Range, No Rsense(TM) Step-Down Controller

LTC1779

250mA Current Mode Step-Down DC/DC Controller in SOT-23

LTC1871

Wide Input Range, No Rsense(TM) Current Mode Boost, Flyback and SEPIC Controller

LTC1872

Constant Frequency Current Mode Step-Up DC/DC Controller in SOT-23

LTC1872B

Constant Frequency Current Mode Step-Up DC/DC Controller in SOT-23

LTC1874

Dual Constant Frequency Current Mode Step-Down DC/DC Controller

LTC1873

Dual 550kHz Synchronous 2-Phase Switching Regulator Controller with 5-Bit VID

LTC1877

High Efficiency Monolithic Synchronous Step-Down Regulator(Note External sync. capability is not modeled)

LTC1878

High Efficiency Monolithic Synchronous Step-Down Regulator(Note External sync. capability is not modeled)

LTC1922-1

Synchronous Phase Modulated Full-Bridge Controller

LTC1929

2-Phase, High Efficiency, Synchronous Step-Down Switching Regulator

LTC1929-PG

2-Phase, High Efficiency, Synchronous Step-Down
Switching Regulator

LTC1986

3V/5V SIM Power Supply in SOT-23

LTC3200

Low Noise, Regulated Charge Pump DC/DC Converter,
Adjustable Output

LTC3200-5

Low Noise, Regulated Charge Pump DC/DC Converter, 5V
Fixed Output

LTC3401

1A, 3MHz Micropower Synchronous Boost Converter

LTC3402

2A, 3MHz Micropower Synchronous Boost Converter

LTC3404

1.4MHz High Efficiency Monolithic Synchronous Step-
Down Regulator (Note External sync. capability is not
modeled)

LTC3405

1.5MHz, 250mA, Synchronous Step-Down Regulator in
ThinSOT

LTC3716

2-Phase, 5-Bit VID, Current Mode, High Efficiency,
Synchronous Step-Down Switching Regulator

LTC3711

5-Bit Adjustable, Wide Operating Range, No Rsense(TM)
Step-Down Controller

LTC3713

Low Input Voltage, High Power, No Rsense(TM)
Synchronous Controller

LTC3714

5-Bit Adjustable, Wide Operating Range, No Rsense(TM)
Step-Down Controller

LTC3728

High Efficiency, 2-Phase Synchronous Step-Down
Switching Regulator

LTC3729

550KHz, PolyPhase, High Efficiency, Synchronous Step-
Down Switching Regulator

Operational Amplifiers

LT1001

Precision Operational Amplifier

LT1001A

Precision Operational Amplifier

LT1001S8

Precision Operational Amplifier

LT1002

Precision Operational Amplifier

LT1002A

Precision Operational Amplifier

LT1006

Precision Single Supply Operational Amplifier

LT1006A

Precision Single Supply Operational Amplifier

LT1006S8

Precision Single Supply Operational Amplifier

LT1007

Low noise, High Speed Precision Operational Amplifier

LT1007A

Low noise, High Speed Precision Operational Amplifier

LT1007CS

Low noise, High Speed Precision Operational Amplifier

LT1008

Picoamp Input Current, μ Volt Offset, Low Noise
Operational Amplifier

LT1010

Fast \pm 150mA Power Buffer

LT1012

Picoamp Input Current, μ Volt Offset, Low noise
Operational Amplifier

LT1012A

Picoamp Input Current, μ Volt Offset, Low noise
Operational Amplifier

LT1012D

Picoamp Input Current, μ Volt Offset, Low noise
Operational Amplifier

LT1012S8

Picoamp Input Current, μ Volt Offset, Low noise
Operational Amplifier

LT1013

Dual Precision Operational Amplifier

LT1013A

Dual Precision Operational Amplifier

LT1013D

Dual Precision Operational Amplifier

LT1014

Quad Precision Operational Amplifier

LT1014A

Quad Precision Operational Amplifier

LT1014D

Quad Precision Operational Amplifier

LT1022

High Speed, Precision JFET Input Operational Amplifier

LT1022A

High Speed, Precision JFET Input Operational Amplifier

LT1024

Dual, Matched Picoamp μ Volt Input, Low Noise
Operational Amplifier

LT1024A

Dual, Matched Picoamp μ Volt Input, Low Noise
Operational Amplifier

LT1028

Ultra-Low Noise Precision High Speed Operational
Amplifier

LT1028A

Ultra Low Noise Precision High Speed Operational
Amplifier

LT1028CS

Ultra Low Noise Precision High Speed Operational
Amplifier

LT1028N

Ultra-Low Noise Precision High Speed Operational Amplifier

LT1037

Low Noise, High Speed Operational Amplifier

LT1037A

Low Noise, High Speed Operational Amplifier

LT1037CS

Low Noise, High Speed Operational Amplifier

LT1055

Precision, High Speed, JFET Input Operational Amplifier

LT1055A

Precision, High Speed, JFET Input Operational Amplifier

LT1055S8

Precision, High Speed, JFET Input Operational Amplifier

LT1056

Precision, High Speed, JFET Input Operational Amplifier

LT1056A

Precision, High Speed, JFET Input Operational Amplifier

LT1056S8

Precision, High Speed, JFET Input Operational Amplifier

LT1057

Dual JFET Input Precision High Speed Operational Amplifier

LT1057A

Dual JFET Input Precision High Speed Operational Amplifier

LT1057S

Dual JFET Input Precision High Speed Operational Amplifier

LT1058

Quad JFET Input Precision High Speed Operational Amplifier

LT1058A

Quad JFET Input Precision High Speed Operational Amplifier

LT1077

Micropower Single Supply, Precision Operational Amplifier

LT1077A

Micropower Single Supply, Precision Operational Amplifier

LT1078

Micropower Dual, Single Supply, Precision Operational Amplifier

LT1078A

Micropower Dual, Single Supply, Precision Operational Amplifier

LT1079

Micropower Quad, Single Supply, Precision Operational Amplifier

LT1079A

Micropower Quad, Single Supply, Precision Operational Amplifier

LT1097

Low Cost Low Power Precision Operational Amplifier

LT1101

Precision Micropower Single Supply Instrumentation Amplifier(Fixed Gain = 10 or 100)

LT1101A

Precision Micropower Single Supply Instrumentation Amplifier(Fixed Gain = 10 or 100)

LT1102

High Speed Precision JFET Input Instrumentation Amplifier(Fixed Gain = 10 or 100)

LT1102A

High Speed Precision JFET Input Instrumentation Amplifier(Fixed Gain = 10 or 100)

LT1112

Dual Low Power Precision Picoamp Operational Amplifier

LT1113

Dual Low Noise Precision JFET Input Operational Amplifier

LT1114

Quad Low Power Precision Picoamp Operational Amplifier

LT1115

Ultra-Low Noise Low Distortion, Audio Operational Amplifier

LT1122

Fast Settling JFET Input Operational Amplifier

LT1124

Dual Low Noise High Speed Precision Operational Amplifier

LT1125

Quad Low Noise High Speed Precision Operational Amplifier

LT1126

Dual Decompensated Low Noise High Speed Operational Amplifier

LT1127

Quad Decompensated Low Noise High Speed Operational Amplifier

LT1128

Unity Gain Stable Ultra-Low Noise Precision High Speed Operational Amplifier

LT1167

Single Resistor Gain Programmable Precision Instrumentation Amplifier

LT1168

Micropower Single Resistor Gain Programmable Precision Instrumentation Amplifier

LT1169

Dual Low Noise, Picoampere Bias Current, JFET Input Operational Amplifier

LT1178

17mA Max, Dual Single Supply Precision Operational Amplifier

LT1178A

17mA Max, Dual Single Supply Precision Operational Amplifier

LT1179

17mA Max, Quad Single Supply Precision Operational Amplifier

LT1179A

17mA Max, Quad Single Supply Precision Operational Amplifier

LT1187

Low Power Video Difference Amplifier

LT1189

Low Power Video Difference Amplifier

LT1190

Ultra High Speed Operational Amplifier ($A_v \geq 1$)

LT1191

Ultra High Speed Operational Amplifier ($A_v \geq 1$)

LT1193

Video Difference Amplifier, Adjustable Gain

LT1194

Video Difference Amplifier, Gain of 10

LT1195

Low Power, High Speed Operational Amplifier

LT1206

250mA/60MHz Current Feedback Amplifier

LT1207

Dual 250mA/60MHz Current Feedback Amplifier

LT1208

Dual 45MHz, 400V/ μ s Operational Amplifier

LT1209

Quad 45MHz, 400V/ μ s Operational Amplifier

LT1210

1.1A, 35MHz Current Feedback Amplifier

LT1211

14Mhz, 7V/ μ s, Single Supply Dual Precision Operational Amplifier

LT1212

14Mhz, 7V/ μ s, Single Supply Quad Precision Operational Amplifier

LT1213

28Mhz, 12V/ μ s, Single Supply Dual Precision Operational Amplifier

LT1214

28Mhz, 12V/ μ s, Single Supply Quad Precision Operational Amplifier

LT1215

23Mhz, 50V/ μ s, Single Supply Dual Precision Operational Amplifier

LT1216

23Mhz, 50V/ μ s, Single Supply Quad Precision Operational Amplifier

LT1217

Low Power High Speed Current Feedback Amplifier

LT1218

Precision Rail-to-Rail Input and Output Operational Amplifier

LT1219

Precision Rail-to-Rail Input and Output Operational Amplifier

LT1220

Very High Speed Operational Amplifier($A_v \geq 1$)

LT1221

Very High Speed Operational Amplifier($A_v \geq 4$)

LT1222

Low Noise, Very High Speed Operational Amplifier($A_v \geq 10$)

LT1223

100MHz Current Feedback Amplifier

LT1224

Very High Speed Operational Amplifier($A_v \geq 1$)

LT1225

Very High Speed Operational Amplifier($A_v \geq 5$)

LT1226

Very High Speed Operational Amplifier($A_v \geq 25$)

LT1227

140MHz Video Current Feedback Amplifier

LT1228

100MHz Current Feedback Amplifier with DC Gain Control

LT1229

Dual 100MHz Current Feedback Amplifier

LT1230

Quad 100MHz Current Feedback Amplifier

LT1251

40Mhz Video Fader and DC Gain Controlled Amplifier

LT1252

Low Cost Video Amplifier

LT1253

Dual Low Cost Video Amplifier

LT1254

Quad Low Cost Video Amplifier

LT1256

40Mhz Video Fader and DC Gain Controlled Amplifier

LT1259

Low Cost Dual 130MHz Current Feedback Amplifier with Shutdown

LT1260

Low Cost Triple 130MHz Current Feedback Amplifier with Shutdown

LT1328

4Mbps IrDA Infrared Receiver -- simulate with LT1328PD, the IR diode

LT1328PD

A photodiode similar to a SFH-205 for testing the LT1328, drive the light input with a current source

LT1351

250mA, 3Mhz, 200V/ μ s, Operational Amplifier

LT1352

Dual 250mA, 3Mhz, 200V/ μ s, Operational Amplifier

LT1353

Quad 250mA, 3Mhz, 200V/ μ s, Operational Amplifier

LT1354

12Mhz, 400V/ μ s, Operational Amplifier

LT1355

Dual 12Mhz, 400V/ μ s, Operational Amplifier

LT1356

Quad 12Mhz, 400V/ μ s, Operational Amplifier

LT1357

25Mhz, 600V/ μ s, Operational Amplifier

LT1358

Dual 25Mhz, 600V/ μ s, Operational Amplifier

LT1359

Quad 25Mhz, 600V/ μ s, Operational Amplifier

LT1360

50Mhz, 800V/ μ s, Operational Amplifier

LT1361

Dual 50Mhz, 800V/ μ s, Operational Amplifier

LT1362

Quad 50Mhz, 800V/ μ s, Operational Amplifier

LT1363

70Mhz, 1000V/ μ s, Operational Amplifier

LT1364

Dual 70Mhz, 1000V/ μ s, Operational Amplifier

LT1365

Quad 70Mhz, 1000V/ μ s, Operational Amplifier

LT1366

Dual Precision Rail-to-Rail Input and Output
Operational Amplifier

LT1367

Quad Precision Rail-to-Rail Input and Output
Operational Amplifier

LT1368

Dual Precision Rail-to-Rail Input and Output
Operational Amplifier

LT1369

Quad Precision Rail-to-Rail Input and Output
Operational Amplifier

LT1395

400Mhz Current Feedback Amplifier

LT1396

Dual 400Mhz Current Feedback Amplifier

LT1397

Quad 400Mhz Current Feedback Amplifier

LT1398

Dual Low Cost 300MHz Current Feedback Amplifier with
Shutdown

LT1399

Triple Low Cost 300MHz Current Feedback Amplifier with
Shutdown

LT1413

Single Supply, Dual Precision Operational Amplifier

LT1413A

Single Supply, Dual Precision Operational Amplifier

LT1431

Programmable Reference

LT1462

Dual Micropower 260 μ W C-Load Picoampere Bias Current
JFET Input Operational Amplifier

LT1463

Quad Micropower 260 μ W C-Load Picoampere Bias Current
JFET Input Operational Amplifier

LT1464

Dual Micropower 1MHz C-Load Picoampere Bias Current
JFET Input Operational Amplifier

LT1465

Quad Micropower 1MHz C-Load Picoampere Bias Current
JFET Input Operational Amplifier

LT1466

Dual Micropower Precision Rail-to-Rail Input and
Output Operational Amplifier

LT1466L

Dual Micropower Precision Rail-to-Rail Input and
Output Operational Amplifier

LT1467

Quad Micropower Precision Rail-to-Rail Input and
Output Operational Amplifier

LT1467L

Quad Micropower Precision Rail-to-Rail Input and
Output Operational Amplifier

LT1468

90MHz, 22V/ μ s, 16-Bit Accurate Operational Amplifier

LT1468N

90MHz, 22V/ μ s, 16-Bit Accurate Operational Amplifier -
- This version of the model includes noise

LT1469

Dual 90MHz, 22V/ μ s, 16-Bit Accurate Operational Amplifier

LT1490

Dual Micropower Precision Rail-to-Rail Input and Output Operational Amplifier

LT1491

Quad Micropower Precision Rail-to-Rail Input and Output Operational Amplifier

LT1492

Dual 5MHz, 3V/ μ s Low Power Single Supply Precision Operational Amplifier

LT1493

Quad 5MHz, 3V/ μ s Low Power Single Supply Precision Operational Amplifier

LT1495

Dual 15 μ A Max, Precision Rail-to-Rail Input and Output Operational Amplifier

LT1496

Quad 15 μ A Max, Precision Rail-to-Rail Input and Output Operational Amplifier

LT1497

Dual 125mA, 50MHz, Current Feedback Amplifier

LT1498

Dual 10MHz, 6V/ μ s, Rail-to-Rail Input and Output Precision C-Load Operational Amplifier

LT1499

Quad 10MHz, 6V/ μ s, Rail-to-Rail Input and Output Precision C-Load Operational Amplifier

LT1630

Dual 30MHz, 10V/ μ s, Rail-to-Rail Input and Output Precision Operational Amplifier

LT1631

Quad 30MHz, 10V/ μ s, Rail-to-Rail Input and Output Precision Operational Amplifier

LT1632

Dual 45MHz, 45V/ μ s, Rail-to-Rail Input and Output Precision Operational Amplifier

LT1633

Quad 45MHz, 45V/ μ s, Rail-to-Rail Input and Output Precision Operational Amplifier

LT1635

Micropower Rail-to-Rail Operational Amplifier and Reference

LT1636

Over-The-Top Micropower Rail-to-Rail Input and Output Operational Amplifier with Shutdown

LT1637

1.1MHz, 0.4V/ μ s Over-The-Top Micropower Rail-to-Rail Input and Output Operational Amplifier

LT1638

Dual 1.2MHz, 0.4V/ μ s, Over-The-Top Micropower Rail-to-Rail input and output Operational Amplifier

LT1639

Dual 1.2MHz, 0.4V/ μ s, Over-The-Top Micropower Rail-to-Rail input and output Operational Amplifier

LT1677

Low Noise, Rail-to-Rail Input and Output Precision Operational Amplifier

LT1782

Micropower Over-The-Top, SOT-23, Rail-to-Rail Input and Output Operational Amplifier

LT1783

1.2MHz Micropower Over-The-Top, SOT-23, Rail-to-Rail Input and Output Operational Amplifier

LT1787

Single Resistor Gain Programmable, Precision Instrumentation Amplifier

LT1793

Low Noise, Picoampere Bias Current, JFET Input Operational Amplifier

LT1795

Dual 500mA/50MHz Current Feedback Amplifier/xDSL Line Driver

LT1806

325MHz, Single Rail-to-Rail Input and Output, Low Distortion, Low Noise Precision Operational Amplifier

LT1807

325MHz, Dual Rail-to-Rail Input and Output, Low Distortion, Low Noise Precision Operational Amplifier

LT1809

Single 180MHz, 350V/ μ s, Rail-to-Rail Input and Output, Low Distortion, Low Noise Precision Operational Amplifier

LT1792

Low Noise, Precision, JFET Input Operational Amplifier

LT1810

Dual 180MHz, 350V/ μ s, Rail-to-Rail Input and Output, Low Distortion, Low Noise Precision Operational Amplifier

LT1812

3mA, 100MHz, 750V/ μ s Operational Amplifier with Shutdown

LT1881

Dual Rail-to-Rail Output pA Input Precision Operational Amplifier

LT1884

Dual Rail-to-Rail Output pA Input Precision Operational Amplifier

LT1886

Dual 700MHz, $A_v \geq 10$, 200mA Operational Amplifier

LT1920

Single Resistor Gain Programmable, Precision Instrumentation Amplifier

LT2078

Dual Micropower Single Supply Precision Operational Amplifier

LT2078A

Dual Micropower Single Supply Precision Operational Amplifier

LT2079

Quad Micropower Single Supply Precision Operational Amplifier

LT2079A

Quad Micropower Single Supply Precision Operational Amplifier

LT2178

Quad 17mA Max, Single Supply Precision Operational Amplifier

LT2178A

Quad 17mA Max, Single Supply Precision Operational Amplifier

LT2179

Quad 17mA Max, Single Supply Precision Operational Amplifier

LT2179A

Quad 17mA Max, Single Supply Precision Operational Amplifier

LTC1043

Dual Instrumentation Switched Capacitor Building Block

LTC1047

Dual Micropower Chopper Stabilized Operational Amplifier with Internal Capacitors

LTC1049

Precision Low Power Zero-Drift Operational Amplifier with Internal Capacitors

LTC1050

Precision Zero-Drift Operational Amplifier with Internal Capacitors

LTC1050A

Precision Zero-Drift Operational Amplifier with Internal Capacitors

LTC1051

Dual Precision Zero-Drift Operational Amplifier with Internal Capacitors

LTC1051A

Dual Precision Zero-Drift Operational Amplifier with Internal Capacitors

LTC1052

Chopper-Stabilized Operational Amplifier

LTC1052CS

Chopper-Stabilized Operational Amplifier

LTC1053

Quad Precision Zero-Drift Operational Amplifier with Internal Capacitors

LTC1100

Precision, Chopper-Stabilized Instrumentation Amplifier

LTC1100A

Precision, Chopper-Stabilized Instrumentation Amplifier

LTC1150

+/-15V Zero-Drift Operational Amplifier with Internal Capacitors

LTC1151

Dual +/-15V Zero-Drift Operational Amplifier

LTC1152

Rail-to-Rail Input and Output Zero-Drift Operational Amplifier

LTC1250

Very Low Noise Zero-Drift Bridge Amplifier

LTC1541

Micropower Operational Amplifier, Comparator and Reference

LTC1542

Micropower Operational Amplifier and Comparator

LTC2050

Low Noise, Zero-Drift Operational Amplifier in SOT-23

LTC7652

Chopper-Stabilized Operational Amplifier

OPAMP

Ideal single-pole operational amplifier. You must `.lib opamp.sub`

Miscellaneous

Voltage

A `voltage` source.

OR

OR gate

The input logic threshold defaults to 0.5V and the output switches between 0V and 1V. Unused pins should not be connect to any wire. Unused pins are connected to the common node of the device and not used during the SPICE simulation. The common node will default to GROUND. Both output pins can be connected floating wires and probed after simulation. The logic threshold defaults to the average of Vhigh and Vlow of the output levels.

Parameters:

Trise: Rise time. Defaults to 0.

Tfall: Fall Time, Defaults to trise if not specified.

Td: Gate delay time.

Vlow: Low output level. Defaults to 0V.

Vhigh: High output level. Defaults to 1V.

Vt: Logic threshold. Defaults to the average of Vhigh and Vlow.

hold-time is equal to the delay. If the delay time 10ns, the input has to hold the level for more than 10ns to validate the logic level.

SCHMITT

Schmitt Trigger

Uses vhigh and vlo

Parameters:

Trise: Rise time, defaults to 0.

Tfall: Fall Time, defaults to Trise.

Td: Gate delay time.

Vlow: Low output level, defaults to 0V.

Vhigh: High output level, defaults to 1V.

Vt: Logic threshold, defaults to the average of Vhigh and Vlow.

Vh: hysteresis voltage, the trip points are $Vt+Vh$ and $Vt-Vh$

SCHMTINV

Schmitt Trigger (Inverting output)

Same the SCHMITT with only one inverting output. SCHMITT has both inverting and non-inverting outputs.

XOR

5-input Exclusive OR gate

The output is true if one and only one input is true.

Parameters:

Trise: Rise time, Defaults to 0.

Tfall: Fall Time, Defaults to Trise.

Td: Gate delay time.

Vlow: Low output level, defaults to 0V.

Vhigh: High output level, defaults to 1V.

Ref: Logic threshold, defaults to the average of Vhigh and Vlow.

SCHMTBUF

Schmitt Trigger (non-inverting output)

Same the SCHMITT with only one non-inverting output.
SCHMITT has both inverting and non-inverting outputs.

AND

5-input AND gate

Parameters:

Trise: Rise time. Defaults to 0.

Tfall: Fall Time, Defaults to Trise if not specified.

Td: Gate delay time.

Vlow: Low output level. Defaults to 0V.

Vhigh: High output level. Defaults to 1V.

Vt: Logic threshold. Defaults to the average of Vhigh and Vlow.

BI

Arbitrary behavioral current sources

BI2

Arbitrary behavioral current sources (opposite polarity)

BV

Arbitrary behavioral voltage sources

BUF

A single input with complementary outputs. It can be used for level translation, impedance buffering and delay insertion.

Parameters:

Trise: Rise time. Defaults to 0.

Tfall: Fall Time, Defaults to Trise if not specified.

Td: Gate delay time.

Vlow: Low output level. Defaults to 0V.

Vhigh: High output level. Defaults to 1V.

Vt: Logic threshold. Defaults to the average of Vhigh and Vlow.

BUF1

same as BUF with only one non-inverting output.

INV

same as buf with inverting output.

CAP

Capacitor

POLCAP

Capacitor

CAPMETER

Capacitance meter that can measure the dynamic capacitance under different biases.

DUT+ : device under test terminal

DUT-: device under test terminal -

Bias: bias the device under test. The bias is applied across the DUT+ and DUT-.

Capacitance: measured capacitance.

Resistance: measured parallel resistance of the device.

SCHOTTKY

Schottky Diode

ZENER

Zener Diode

The main difference between a zener diode and other diodes is the BV (breakdown voltage) parameter in the model.

For example, 1N5234 has a zener voltage of 6.2V. The simplest model is as follows: `.model 1N5234 D(BV=6.2)`

Use the [File] [Open] command to open the diode database:

`.\lib\cmp\standard.dio` and insert the desired models, if necessary. The [Sync Release] will preserve the user's models as long as the model names are different from the default models provided by LTC.

DIODE

Diode

DFLOP

D Flip-Flop

Input: D, CLK, PRE, CLR, Output: Q, `_Q`

Same parameters as OR gate. Data is edge-triggered. Hold time not required.

Unconnected pins are disabled during simulation. Pins can not be connected to dangling wires.

E2

Voltage Dependent Voltage Source (opposite polarity)

G2

Voltage Dependent Current Source (opposite polarity)

CURRENT

Current Source

LOAD

A current source

LOAD2

A current source

NJF

N JEFT transistor

PJF

P JFET Transistor

IND

Inductor

IND2

Inductor(same as IND but drawn with phasing dots)

NMOS

MOS (substrate connected to drain)

NMOS4

MOS (independent substrate node available)

The power MOSFET(VDMOS) model file is
.\lib\cmp\standard.mos. It can be edited by a text editor.
The standard MOSFET(Level 1-8 and BSIM) models can be added
to the standard.mos file.

PMOS

PMOS

The power MOSFET(VDMOS) model file is
.\\lib\\cmp\\standard.mos. It can be edited by a text editor.
The standard MOSFET(Level 1-8 and BSIM) models can be added
to the standard.mos file.

PMOS4

PMOS

A symbol that allows one to specify the substrate node for
the monolithic MOSFET devices in traditional SPICE's. You
have to supply the models for these

LTLINE

Lossy Transmission Line

NPN

Bipolar transistor

NPN2

Bipolar transistor

PNP

PNP

PNP2

RES

Resistor

RES2

Resistor

SW

Voltage Controlled switch.

TLINE

Lossless Transmission Line

SIGNAL

Voltage Source

CSW

Current controlled switch

OPAMP

Idealized single-pole operational amplifier. The SPICE directive `'.include standard.opamp'` must be entered on the schematic page to include the subcircuit of OpAmp.

Default value: `Aol=100K, GBW=10Meg`

*

```
.subckt opamp 1 2 3  
G1 0 3 2 1 {Aol}
```

```
R3 3 0 1.  
C3 3 0 {Aol/GBW/6.28318530717959}  
.ends opamp
```

OPAMP2

opamp2 Linear Technology OpAmp.

The LTC OpAmp model name must be entered on the [Value] attribute of the symbol. The SPICE syntax '.lib standard.opamp' must be entered

on the schematic page to reference the OpAmp library.

MESFET

MESFET transistor

XTAL

Piezoelectric crystal. Set C, Lser and Cpar to set series and parallel resonances. This is actually the same circuit element as a capacitor and is just using LTspice's ability to model a capacitor's parasitic series inductance in the capacitor device. Note that there is a performance advantage to modeling a crystal in this manor over the usual macro model of discrete lumped constants. There are no internal nodes in this device so the overall circuit matrix is smaller and the simulation runs faster.

CELL

Voltage Source, either DC, AC, PULSE, SINE, PWL, EXP, or SFFM

DIP10

Generic Symbol for use with subcircuits that you supply.

DIP14

Generic Symbol for use with subcircuits that you supply.

DIP16

Generic Symbol for use with subcircuits that you supply.

DIP20

Generic Symbol for use with subcircuits that you supply.

DIP8

Generic Symbol for use with subcircuits that you supply.

JUMPER

A wire jumper. This component lets you give the same net two different names

SIGNAL

Voltage Source, either DC, AC, PULSE, SINE, PWL, EXP, or SFFM

TOWTOM2

2nd Order Tow-Thomas Filter building block. Needs .lib TowTom2.sub & .params R=10K C=160p GBW1=10Meg GB2=15Meg Aol=100K

2nd order section of LTC1562 or LTC1562-2.

LTC1562: Very Low Noise, Low Distortion Active RC

Quad Universal Filter

* Copyright © Linear Technology Corp. 98,99,2000. All rights reserved.

*

```
.subckt TowTom2 1 2 3
C1 1 3 {C}
C3 N001 1 3p
C4 N002 N001 .3p
C7 2 N003 {C}
C6 2 3 1p
R2 N001 1 10K
R3 N002 N001 10K
R5 N003 N002 {R}
R1 1 0 1.
C2 1 0 {Aol/GBW1/6.28318530717959}
G1 0 1 0 3 {Aol}
R6 2 0 1.
C8 2 0 {Aol/GBW1/6.28318530717959}
```

```

G3 0 2 0 N003 {Aol}
R4 N002 0 1.
C5 N002 0 {Aol/GBW2/6.28318530717959}
G2 0 N002 0 N001 {Aol}
.params R=10K C=160p GBW1=10Meg GBW2=15Meg
.params Aol=100K
.ends TowTom2

```

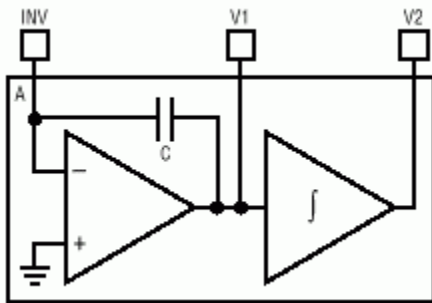

URC

Uniform RC-line. Intended for interconnection on IC's but rarely used.

URC2

Uniform RC-line. Intended for interconnection on IC's but rarely used.

BATTERY

Voltage Source, either DC, AC, PULSE, SINE, PWL, EXP, or SFFM

Opto Isolators

4N25

Optoisolator, Transistor Output

4N25A

Optoisolator, Transistor Output

4N26

Optoisolator, Transistor Output

4N27

Optoisolator, Transistor Output

4N28

Optoisolator, Transistor Output

CNY17-1

Optoisolator, Transistor Output

CNY17-2

Optoisolator, Transistor Output

CNY17-3

Optoisolator, Transistor Output

MOC205

Optoisolator, Transistor Output

MOC206

Optoisolator, Transistor Output

MOC207

Optoisolator, Transistor Output

PC817A

High Density Mounting Type Photocoupler

PC817B

High Density Mounting Type Photocoupler

PC817C

High Density Mounting Type Photocoupler

PC817D

High Density Mounting Type Photocoupler

Special Functions

MODULATE

Behavioral Modulator. Output is a sine wave modulated by AM and FM input voltages.

SINE wave generator with voltage-controlled amplitude and frequency. The amplitude is controlled by the input labeled AM. If left unconnected, the amplitude defaults to one Volt. The frequency is controlled by the FM pin. The conversion from voltage to frequency is defined by MARK(1V input) and SPACE(0V input) frequencies.

CAPMETER

A vector impedance meter. You must place the SPICE directive, ".lib capometer.sub", on the schematic to use this symbol.

VARISTOR

Voltage controlled varistor. The breakdown voltage is programmed with the control inputs. There is an example file, examples\Educational\varistor.asc, that shows using this device.

Filter Products

LTC1562-2

Very Low Noise, Low Distortion Active RC Quad Universal Filter NOTE: GBW, slew rate and noise are modeled in this otherwise highly idealized macromodel.

LTC1562

Very Low Noise, Low Distortion Active RC Quad Universal Filter NOTE: GBW, slew rate and noise are modeled in this otherwise highly idealized macromodel.

LTC1562A

Very Low Noise, Low Distortion Active RC Quad Universal Filter NOTE: GBW, slew rate and noise are modeled in this otherwise highly idealized macromodel.

Digital

AND

Behavioral AND gate

Parameters:

Trise: Rise time, Defaults to 0.

Tfall: Fall Time, Defaults to Trise.

Td: Gate delay time.

Vlow: Low output level, defaults to 0V.

Vhigh: High output level, defaults to 1V.

Ref: Logic threshold, defaults to the average of Vhigh and Vlow.

BUF

Behavioral buffer with complementary outputs

Parameters:

Trise: Rise time, Defaults to 0.

Tfall: Fall Time, Defaults to Trise.

Td: Gate delay time.

Vlow: Low output level, defaults to 0V.

Vhigh: High output level, defaults to 1V.

Ref: Logic threshold, defaults to the average of Vhigh and Vlow.

BUF1

Behavioral buffer

Parameters:

Trise: Rise time, Defaults to 0.

Tfall: Fall Time, Defaults to Trise.

Td: Gate delay time.

Vlow: Low output level, defaults to 0V.

Vhigh: High output level, defaults to 1V.

Ref: Logic threshold, defaults to the average of Vhigh and Vlow.

DFLOP

Behavioral D-flipflop

Parameters:

Trise: Rise time, Defaults to 0.

Tfall: Fall Time, Defaults to Trise.

Td: Gate delay time.

Vlow: Low output level, defaults to 0V.

Vhigh: High output level, defaults to 1V.

Ref: Logic threshold, defaults to the average of Vhigh and Vlow.

INV

Behavioral Inverter

Parameters:

Trise: Rise time, Defaults to 0.

Tfall: Fall Time, Defaults to Trise.

Td: Gate delay time.

Vlow: Low output level, defaults to 0V.

Vhigh: High output level, defaults to 1V.

Ref: Logic threshold, defaults to the average of Vhigh and Vlow.

OR

Behavioral OR gate with complementary outputs

Parameters:

Trise: Rise time, Defaults to 0.

Tfall: Fall Time, Defaults to Trise.
Td: Gate delay time.
Vlow: Low output level, defaults to 0V.
Vhigh: High output level, defaults to 1V.
Ref: Logic threshold, defaults to the average of Vhigh and Vlow.

SCHMITT

Behavioral Schmitt-Triggered buffer with complementary outs

Parameters:

Trise: Rise time, defaults to 0.
Tfall: Fall Time, defaults to Trise.
Td: Gate delay time.
Vlow: Low output level, defaults to 0V.
Vhigh: High output level, defaults to 1V.
Vt: Logic threshold, defaults to the average of Vhigh and Vlow.
Vh: hysteresis voltage, the trip points are $Vt+Vh$ and $Vt-Vh$

SCHMTBUF

Behavioral Schmitt-Triggered buffer

Parameters:

Trise: Rise time, defaults to 0.
Tfall: Fall Time, defaults to Trise.
Td: Gate delay time.
Vlow: Low output level, defaults to 0V.
Vhigh: High output level, defaults to 1V.

Vt: Logic threshold, defaults to the average of Vhigh and Vlow.

Vh: hysteresis voltage, the trip points are $Vt+Vh$ and $Vt-Vh$

SCHMTINV

Behavioral Schmitt-Triggered inverter

Parameters:

Trise: Rise time, defaults to 0.

Tfall: Fall Time, defaults to Trise.

Td: Gate delay time.

Vlow: Low output level, defaults to 0V.

Vhigh: High output level, defaults to 1V.

Vt: Logic threshold, defaults to the average of Vhigh and Vlow.

Vh: hysteresis voltage, the trip points are $Vt+Vh$ and $Vt-Vh$

SRFLOP

Behavioral Set-Reset Flipflop

XOR

Behavioral XOR gate

Diffschmtinv

Behavioral Schmitt-Triggered Inverter with Differential Input

Parameters:

Trise: Rise time, defaults to 0.

Tfall: Fall Time, defaults to Trise.

Td: Gate delay time.

Vlow: Low output level, defaults to 0V.

Vhigh: High output level, defaults to 1V.

Vt: Logic threshold, defaults to the average of Vhigh and Vlow.

Vh: hysteresis voltage, the trip points are $Vt+Vh$ and $Vt-Vh$

Diffschmtbuf

Behavioral Schmitt-Triggered Buffer with Differential Input

Parameters:

Trise: Rise time, defaults to 0.

Tfall: Fall Time, defaults to Trise.

Td: Gate delay time.

Vlow: Low output level, defaults to 0V.

Vhigh: High output level, defaults to 1V.

Vt: Logic threshold, defaults to the average of Vhigh and Vlow.

Vh: hysteresis voltage, the trip points are $Vt+Vh$ and $Vt-Vh$

Diffschmitt

Behavioral Schmitt-Triggered Buffer with Complementary Outs and Differential Input

Parameters:

Trise: Rise time, defaults to 0.

Tfall: Fall Time, defaults to Trise.

Td: Gate delay time.

Vlow: Low output level, defaults to 0V.

Vhigh: High output level, defaults to 1V.

Vt: Logic threshold, defaults to the average of Vhigh and Vlow.

Vh: hysteresis voltage, the trip points are Vt+Vh and Vt-Vh

PHIDET

Behavioral type II phase detector. NOTE: It is best to limit input rise times

Comparators

LT1016

Ultra Fast Precision Comparator

LT1116

12ns, Single Supply Ground-Sensing Comparator

LT1394

7ns, Low Power Single Supply, Ground-Sensing Comparator

LT1671

60ns, Low Power, Single Supply, Ground-Sensing Comparator

LT1720

Dual 4.5ns, Single Supply 3V/5V Comparator with Rail-to-Rail Outputs

LT1721

Quad 4.5ns, Single Supply 3V/5V Comparator with Rail-to-Rail Outputs

LTC1041

BANG-BANG Controller

LTC1042

Window Comparator

LTC1440

Ultralow Power Comparator with Reference

LTC1441

Dual Ultralow Power Comparator with Reference

LTC1442

Dual Ultralow Power Comparator with Reference

LTC1443

Quad Ultralow Power Comparator with Reference

LTC1444

Quad Ultralow Power Comparator with Reference

LTC1445

Quad Ultralow Power Comparator with Reference

LTC1540

Nanopower Comparator with Reference

Preface

Do we need another SPICE?

Analog circuit simulation has been inseparable from analog IC design. SPICE simulators are the only way to test circuitry prior to integration onto a chip. Further, the SPICE simulation allows measurements of currents and voltages that are virtually impossible to do any other way. The success of these analog circuit simulators has made circuit simulation spread to board level circuit design. It is easier in many cases to simulate rather than breadboard, and the ability to analyze the circuit in the simulation for performance and problems speeds the design of well-understood, robust circuits.

Given the number of commercially available SPICE simulators why should a new simulator be written? Because certain analog functions are extremely difficult to simulate with commercially available SPICE simulators. Switch-mode power supplies have fast high frequency switching square waves as well as slow overall loop response. This means simulations must run for thousands to hundreds of thousands of cycles in order to see the overall response of a switching regulator. Commercially available SPICE's simply take too long for this to be a useful simulation method. Simulation times for a switch-mode power supply must be in minutes not hours for a simulator to be useful.

There have been analog circuit simulation methods that have shown some success in speeding up switch mode power supply simulation but at a cost of making simplifying assumptions which don't allow arbitrary control logic and fully simulate the complexity of the switching waveforms. A new SPICE with integrated logic primitives that perform the switch mode control provides a better answer. It can give fast simulation times, yield detailed waveforms, and still allows the flexibility for arbitrary circuit modifications.

SwitcherCAD III is a new SPICE that was developed for modeling board level switching regulator systems.

Incorporated into the new SPICE are circuit elements to model practical board level components. Capacitors and inductors can be modeled with series resistance and other parasitic aspects of their behavior without using sub-circuits or internal nodes. Also, a simulation circuit element was developed for power MOSFET's that accurately exhibits their usual gate charge behavior without using sub-circuits or internal nodes. Reducing the number of nodes the simulator needs to solve significantly reduces the computation required for a given simulation without compromising the accuracy or detail of the switching waveforms. Another benefit of these new simulation devices is that convergence problems are easier to avoid since they, like the board level component the model, have finite impedance at all frequencies.

Modern switch mode power supplies include controller logic with multiple modes of operation. For example, devices may change from pulse switch modulation to burst-mode or to cycle skipping depending on the circuit's operation. An original new mixed-mode compiler and simulator were written into SwitcherCAD III that allows these products to be realistically modeled in a computationally fast manner.

There are currently approximately seven hundred Linear Technology products modeled in SwitcherCAD III. The program is freely downloadable from the Linear Technology website and is a high-performance general-purpose SPICE simulator. Included are demonstration files that allow you to watch step-load response, start-up and transient behavior on a cycle-by-cycle basis. Included with the SPICE is a full-featured schematic entry program for entering new circuits.

SwitcherCAD III is designed to be used by three different types of design engineers: those who know what they're doing, those who think they know, and those who are sure they know absolutely nothing about switching regulator design. The experienced designer needs a "what if" program that allows him to quickly alter aspects of a circuit to find an optimum design. The neophyte needs a cookbook approach that yields a reliable design based on the simplest of inputs. The "loose cannon" designer needs a program that will allow him to exercise his free will, but

will be intelligent enough to alert him to fatal design flaws.

To that end, we made SwitcherCAD III an extremely flexible "what if" electronic design tool that has warning labels when things are getting out of hand. We designed the program to have a complete initial design cycle based only on the essential inputs of voltage and power requirements. This allows the terrified designer to start with a working circuit, permits the experienced designer to have unlimited fun changing things, and, we hope, provides enough safeguards to prevent bad designs.

Please be aware, however, that SwitcherCAD III is not intended as a total solution. It is only a tool to ease the design procedure, which must also include breadboarding and testing. Use common sense with the results obtained from simulation.

SPICE Error Log Command

Use this command to display the simulation log file. A typical log file is shown as follows:

```
Circuit: * D:\XP\lib\app\LT1300-DC035A.app
```

```
Date: Tue Oct 05 16:57:31 1999
```

```
Total elapsed time: 6.64 seconds.
```

```
tnom = 27  
temp = 27  
method = modified trap  
totiter = 14872  
traniter = 14862  
tranpoints = 3865  
accept = 2986  
rejected = 879  
trancuriters = 0  
matrix size = 12  
fillins = 2  
  
solver = Normal
```

Web Update

All windows must be closed first before the Sync_Release command can be activated. The user needs to establish the internet connection first. The SwCAD III program will then download the master index file(release.log) from the LTC web server. The master index file contains the checksums for every file in the sub-directories. The local file's checksum is then calculated and checked against the one in the master index file. The file on the web server will then be downloaded automatically if there is a difference in checksum. SwCAD program files that were saved under the same name will be overwritten! Most of the macromodels are less than 3KB and can be transferred in a few seconds. During the update of the SCAD3.EXE, the new file is first copied to the Windows temp directory and the old SCAD3.EXE is overwritten after the download is complete. The old program is still preserved if the user cancels the file transfer. The changelog.txt file lists the changes of program revisions.

1107

Micropower DC/DC Converter, Adjustable, Fixed 5V, and 12V

1173

Micropower DC/DC Converter, Adjustable, Fixed 5V, and 12V outputs

E

Voltage Dependent Voltage Source

F

Current Dependent Current Source

G

Voltage Dependent Current Source

H

Current Dependent Voltage Source

LT1071

2.5A High Efficiency Switching Regulator

LT1072

1.25A High Efficiency Switching Regulator

LT1074

5A Step-Down Switching Regulator

LT1083

7.5A Low Dropout Positive Adjustable Regulator

LT1109

Micropower Low Cost DC/DC Converter, Adjustable Output Voltage

LT1109-12

Micropower Low Cost DC/DC Converter, Fixed 12V

LT1109-5

Micropower Low Cost DC/DC Converter, Fixed 5V

LT1109A

Micropower DC/DC Converter Flash Memory VPP Generator, Adjustable Output Voltage

LT1109A-12

Micropower DC/DC Converter Flash Memory VPP Generator, Fixed 12V

LT1109A-5

Micropower DC/DC Converter Flash Memory VPP Generator, Fixed 5V

LT1170

100kHz, 5A High Efficiency Switching Regulator

LT1170HV

100kHz, 5A High Efficiency Switching Regulator (High Voltage version)

LT1171

100kHz, 2.5A High Efficiency Switching Regulator

LT1171HV

100kHz, 2.5A High Efficiency Switching Regulator (High Voltage version)

LT1172

100kHz, 1.25A High Efficiency Switching Regulator

LT1172HV

100kHz, 1.25A High Efficiency Switching Regulator

LT1241

High Speed Current Mode Pulse Width Modulator

LT1300

Micropower High Efficiency 3.3/5V Step-Up DC/DC Converter

LT1301

Micropower High Efficiency 5V/12V DC/DC Step-Up Converter for Flash Memory

LT1302

Micropower High Output Current Step-up Adjustable DC/DC Converter

LT1303

Micropower High Efficiency DC/DC Converter with Low-Battery Detector, adjustable output voltage

LT1303-5

Micropower High Efficiency DC/DC Converter with Low-Battery Detector, Fixed 5V

LT1304

Micropower DC/DC Converter with Low-Battery Detector Active in Shutdown, Adjustable output voltage

LT1304-3.3

Micropower DC/DC Converter with Low-Battery Detector Active in Shutdown, Fixed 3.3V

LT1304-5

Micropower DC/DC Converter with Low-Battery Detector Active in Shutdown, Fixed 5V

LT1305

Micropower High Power DC/DC Converter with Low-Battery Detector

LT1307

Single Cell Micropower 600kHz PWM DC/DC Converter

LT1307B

Single Cell Micropower 600kHz PWM DC/DC Converter

LT1308A

High Current, Single Cell Micropower 600kHz DC/DC Converter

LT1308B

High Current, Single Cell Micropower 600kHz DC/DC Converter

LT1309

500kHz Micropower DC/DC Converter for Flash Memory

LT1316

Micropower DC/DC Converter with Programmable Peak Current Limit

LT1375

1.5A, 500kHz Step-Down Switching Regulator, Adjustable Output Voltage

LT1375-5

1.5A, 500kHz Step-Down Switching Regulator, Fixed 5V Output

LT1108

5Volt Micropower DC/DC Converter

LT1111-12

12 Volt Micropower DC/DC Converter

LT1110

Adjustable Micropower DC/DC Converter

LTC1261CS8-4

Switched Capacitor Regulated Voltage Inverter, Fixed 4V Output

LTC1551CS8-4.1

Low Noise, Switched Capacitor Regulated Voltage Inverter, Fixed -4.1V Output

LTC1551LCS8

Low Noise, Switched Capacitor Regulated Voltage Inverter, Adjustable Output Voltage

LTC1551LCS8-4.1

Low Noise, Switched Capacitor Regulated Voltage Inverter, Fixed -4.1V Output

LT1962-3.3

300mA Low Noise Low Dropout Micropower Regulator with Shutdown, 3.3V

LT1761-2

100mA Low Noise Low Dropout Micropower Regulator with Shutdown in SOT-23, 2V Output

LTC1475-3.3

Low Quiescent Current, High Efficiency Step-Down Converter, 3.3V Output

LT1615

Micropower Step-Up DC/DC Converter in SOT-23

LTC1147-5

High Efficiency Step-Down Switching Regulator Controller, Fixed 5V Output

LTC1147L

High Efficiency Step-Down Switching Regulator Controller, Adjustable Output Voltage

LTC1147L-3.3

High Efficiency Step-Down Switching Regulator Controller, Fixed 3.3V Output

LTC1148

High Efficiency Synchronous Step-Down Switching Regulator Controller, Adjustable Output Voltage

LTC1148-3.3

High Efficiency Synchronous Step-Down Switching Regulator Controller, Fixed 3.3V Output

LTC1148-5

High Efficiency Synchronous Step-Down Switching Regulator Controller, Fixed 5V Output

LTC1148HV

High Efficiency Synchronous Step-Down Switching Regulator Controller, Adjustable Output Voltage

LTC1148HV-3.3

High Efficiency Synchronous Step-Down Switching Regulator Controller, Fixed 3.3V Output

LTC1148HV-5

High Efficiency Synchronous Step-Down Switching Regulator Controller, Fixed 5V Output

LT1244

High Speed Current Mode Pulse Width Modulator

LT1813

Dual 3mA, 100Mhz, 750V/ μ s Operational Amplifier

opto isolator section
special function blocks
Filterproducts
misc symbols

Index

.AC -- Perform an AC analysis	74
.BACKANNO -- Annotate the subcircuit pin names on to the port currents	74
.DC -- Perform a DC source sweep analysis	75
.END	75
.ENDS	76
.GLOBAL -- Declare global nodes	77
.IC -- set initial conditions	78
.INCLUDE -- include another file	78
.LIB -- Include a library	79
.MODEL	80
.NODESET -- supply hints for initial DC solution	80
.NOISE -- Perform a noise analysis	81
.OP -- Find the DC operating point	81
.OPTIONS -- Set simulator options	82
.PARAM -- User-defined parameters	84
.SAVE -- Limit the amount of saved data	86
.STEP -- Parameter sweeps	86
.SUBCKT -- define a subcircuit	87
.TEMP -- Temperature sweeps	88
.TF -- Find the DC small-signal transfer function	89
.TRAN -- Do a non-linear transient analysis	89
.TRAN Modifiers	91
.WAVE -- Write selected nodes to a .wav file	90

A

A. General Structure and Conventions	69
A. Special functions	93
Adding Attributes	45
Adding the Pins	44
Application Note Circuits	25
Attached Cursors	64, 65
Attribute Visibility	47
Axis Control	62

B

B. Arbitrary behavioral voltage or current sources	96
B. Circuit description	69

C

C. Simulator directives -- dot commands	73
C. Capacitor	99
Color Control	63
Compression	142, 143
Creating Symbol Overview	43

D	
D. Diode	102
Drawing the body	43
E	
E. Voltage Dependent Voltage Source	104
Edit a visible attribute	39
Efficiency Report	29
Example Circuits	26
Exporting Waveform Data	162
Externally Generated Netlists	28
F	
F. Current Dependent Current Source	106
G	
G. Voltage Dependent Current Source	106
General Attribute Editor	41
General Purpose Schematic Driven SPICE	27
H	
H. Current Dependent Voltage Source	108
Hardware Requirements	20
I	
I. Current Source	108
III. Circuit Element Quick Reference	72
J	
J. JFET transistor	113
K	
K. Mutual Inductance	114
L	
L. Inductor	115
Label a node name	35
License Agreement/Disclaimer	21
LT Spice Overview	68
M	
M. MOSFET	117
Modes of Operation	23
N	
Navigating the Hierarchy	50
Netlist Options	148
O	
O. Lossy Transmission Line	126
Operation	143
Overview	48

P

PCB Netlist Extraction	38
Placing Components	37
Plot Panes	63
Preface	244
Programming Keyboard Shortcuts	37

Q

Q. Bipolar transistor	127
-----------------------------	-----

R

R. Resistor	131
Rules of Hierarchy	49
Runing under Linux	163

S

S. Voltage Controlled Switch	131
Save Plot Configurations	67
Schematic Colors	36
Schematic Editing	31
Software Installation	20
Specialized Component Editors	40
SPICE Error Log Command	246
Starting the Control Panel	141
steady	92
SwitcherCAD III Overview	19
Symbol Editing	38
Symbol Overview	164
Synthesized Circuits	24

T

T. Lossless Transmission Line	132
Trace Selection	52
tran	92
nodiscard	92
startup	92
step	92, 93

U

U. Uniform RC-line	133
User-Defined Functions	61

V

V. Voltage Source	134
Viewer Overview	52

W

W. Current Controlled Switch	138
Waveform Arithmetic	56

X

X. Subcircuit	139
---------------------	-----

Z

Z. MESFET transistor	140
Zooming	56