

EE 2240
Problem #02

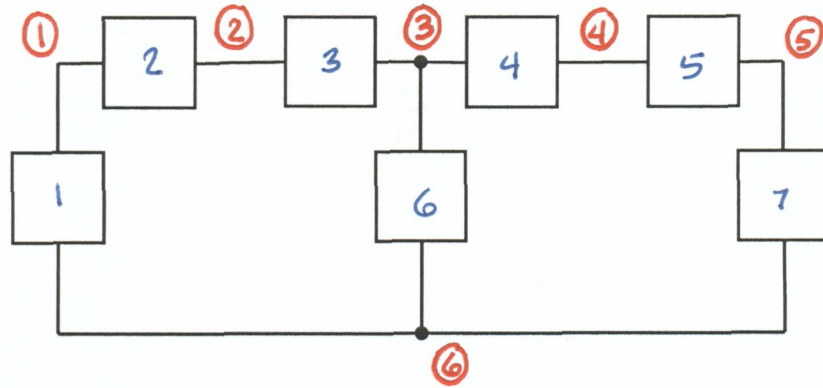

Determine each of the following:

a. The number of nodes.

6

b. The number of branches.

7